



Politechnika
Wroclawska

Construction materials technologies in engineering

Łukasz Sadowski
lukasz.sadowski@pwr.edu.pl

Wroclaw University of Science and Technology
Faculty of Civil Engineering
Department of Materials Engineering and Construction Processes



Politechnika
Wroclawska

Floors made of cement-based materials

Introduction & background

a)

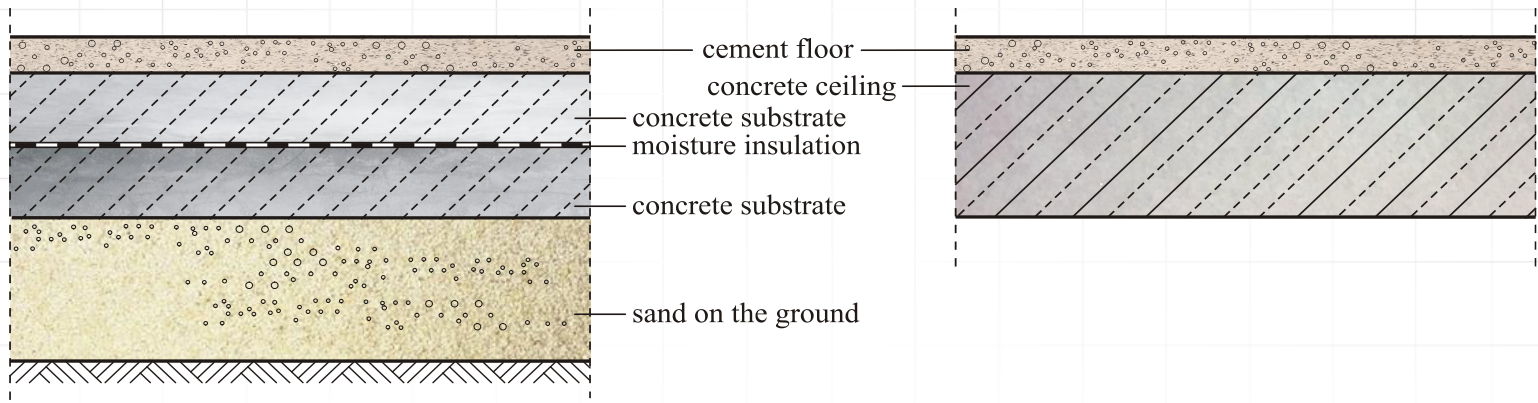

b)

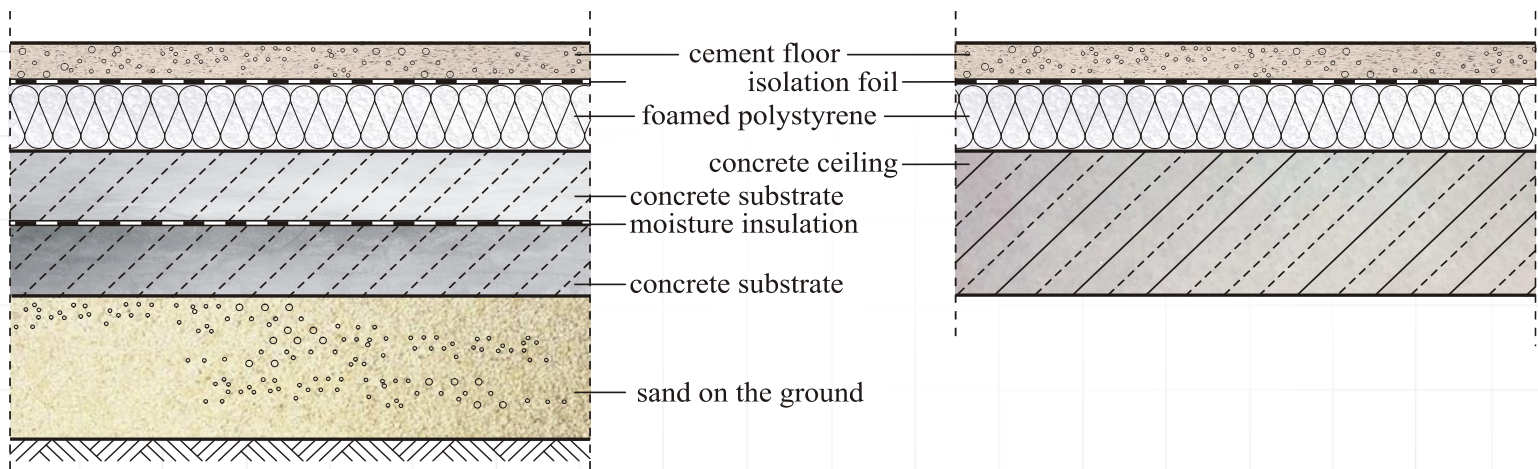

Exemplary variants of various floor systems with the floor made on: a) a concrete substrate or a reinforced concrete ceiling; b) a foamed polystyrene laid on a concrete substrate or reinforced concrete ceiling

Introduction & background

Newly built cement floors



Cracked cement floors



Introduction & background

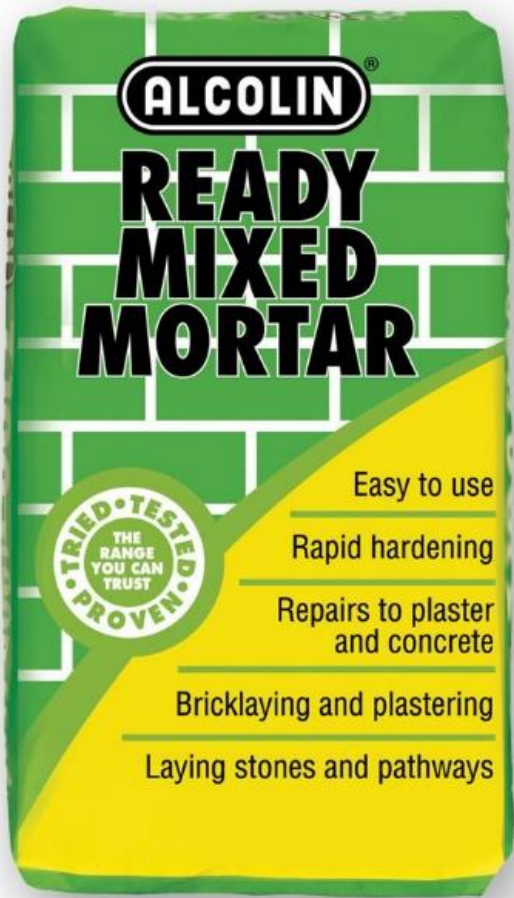

Summary of the major requirements for floors

Important technological and technical requirements

Floor thickness	<ul style="list-style-type: none">- Compliant with the design, usually 40-60 mm
Beginning of the execution of the floor	<ul style="list-style-type: none">- After building windows and doors in the building,- In the absence of so-called drafts that overdry the cement-based material,- Without the possibility of intense sunlight or heating the cement-based material,- At ambient and substrate temperatures between +10°C and +25°C,- At a relative humidity of 65% to 95%.
Preparation of the mixture	<p>Mechanical mixing:</p> <ul style="list-style-type: none">- without homogenizing the mixture,- with homogenizing the mixture according to records in the mix manufacturer's requirements.
Unevenness of the surface of a concrete substrate or reinforced concrete ceiling	<ul style="list-style-type: none">- It is required not to exceed the upper and lower deviations

Summary of the major requirements for floors

Important technological and technical requirements

Execution of peripheral expansion joints	<ul style="list-style-type: none">- For full thickness of floors, made of non-absorbent elastic foam,- Joint width minimum - 7 mm.
Execution of cut expansion joints	<ul style="list-style-type: none">- Maximum field size - 36 m²,- Maximum length of dilated field - 6 m,- The maximum proportions of the sides of the dilated field 1: 1.5,- The minimum depth of cut expansion joints from 1/3 to 1/2 of the floor thickness, at right angles,- Joint widths from 3 to 5 mm.
Deadline for making cut-in expansion joints	<ul style="list-style-type: none">- In the first 24 hours after execution of the floor
Compressive strength	<ul style="list-style-type: none">- According to the project; usually at least 20 MPa
Flexural strength	<ul style="list-style-type: none">- According to the project; usually at least 5 MPa
Subsurface tensile strength	<ul style="list-style-type: none">- According to the project; usually at least 5 MPa
Scratches and cracks	<ul style="list-style-type: none">- They are not allowed
Unevenness of the surface of a floor	<ul style="list-style-type: none">- It is required not to exceed the upper and lower deviations

Examples of frequent defects

A lack of methodical control of the process of executing floors made from cement-based materials results in a defect found not only organoleptically, but also found through control tests using destructive, semi-destructive and non-destructive methods. The most common defects are:

- floor thickness not in accordance with that of the designed one,
- corrugation of insulation foil laid under the floor,
- no circumferential separation of floors from load-bearing walls,
- incorrectly cut expansion joints,
- too low in relation to the required strength parameters of the floor,
- no scratches on the floor surface

Examples of frequent defects

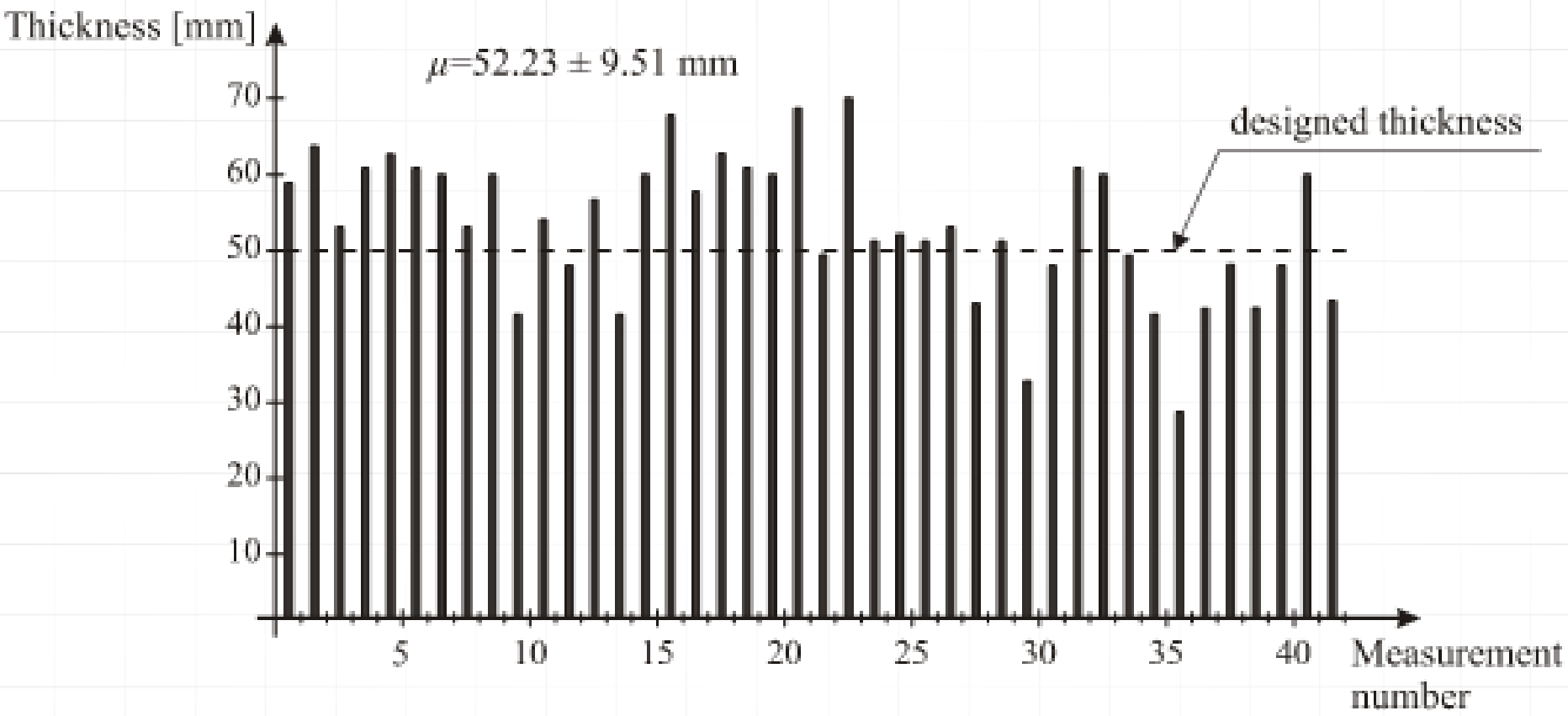

The thickness of the floors determined by the authors of the article in comparison with the designed thickness

Examples of frequent defects



Example view: a) the bottom surface of the floor, with grooved recesses constituting the “imprint” of the corrugated foil,
b) measuring the depth of the grooved cavities

Examples of frequent defects

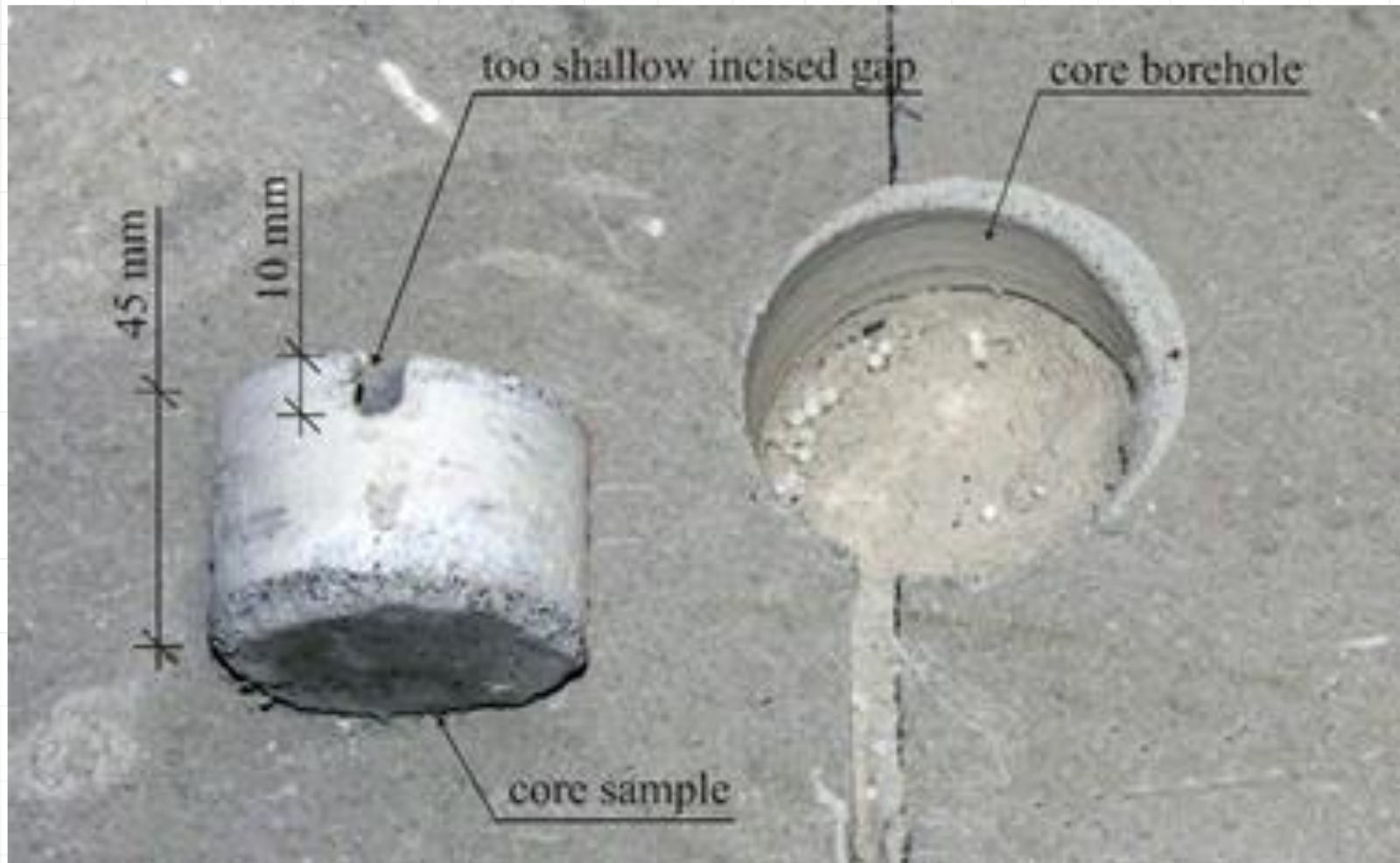

An exemplary view of a core borehole made in the floor, and also a core sample showing an expansion joint cut too shallow

Examples of frequent defects

Sample results of strength tests carried out for one of the cement floors

Summary of average strength values

Subsurface tensile strength f_h [MPa]:

- Obtained on the basis of research
- Required according to Table 1

0.55±0.21
1.5

Compressive strength [MPa]:

- Obtained on the basis of research
- Required according to Table 1

15.1±4.5
20.0

Flexural strength [MPa]:

- Obtained on the basis of research
- Required according to Table 1

2.3±1.0
5.0

Examples of frequent defects

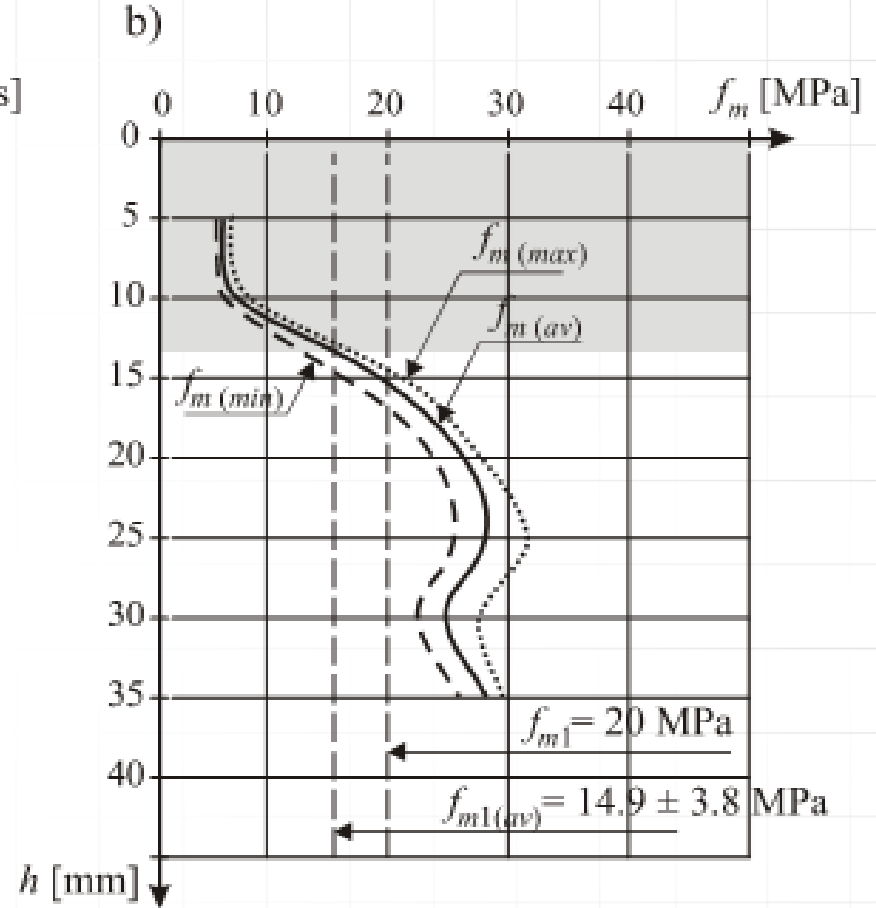
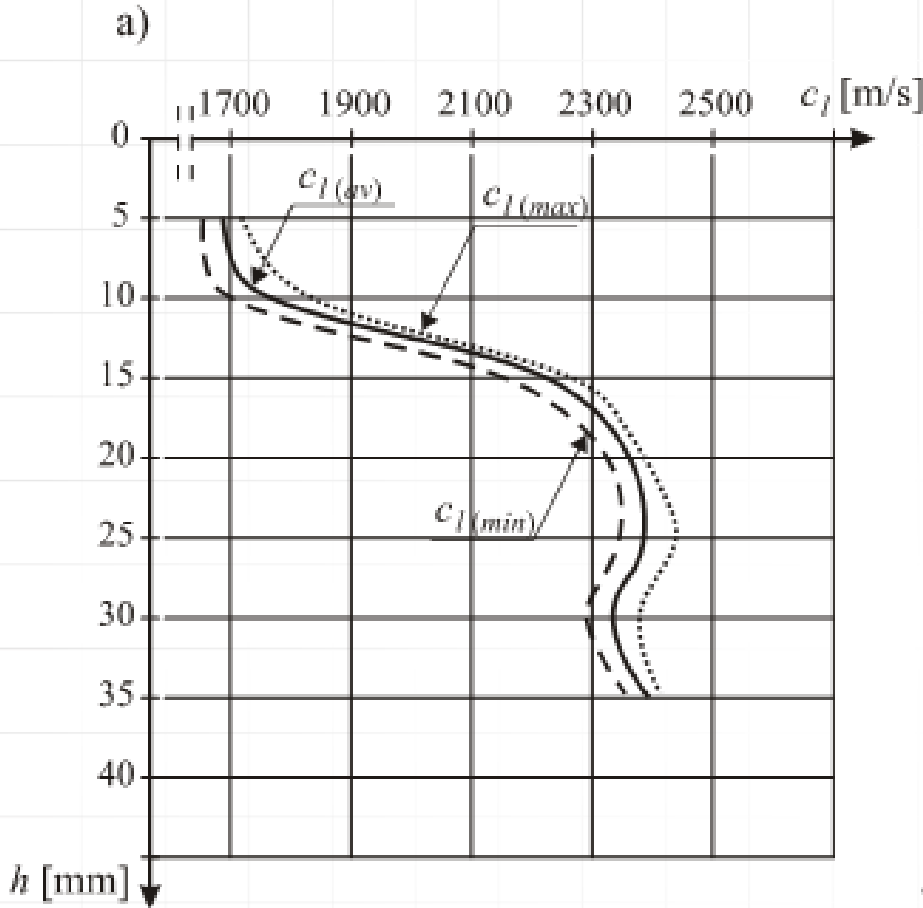

An example of the course: a) the longitudinal velocity of the ultrasonic wave c_l along the thickness h ; b) compressive strength f_m of the cement mortar along thickness h

Examples of frequent defects

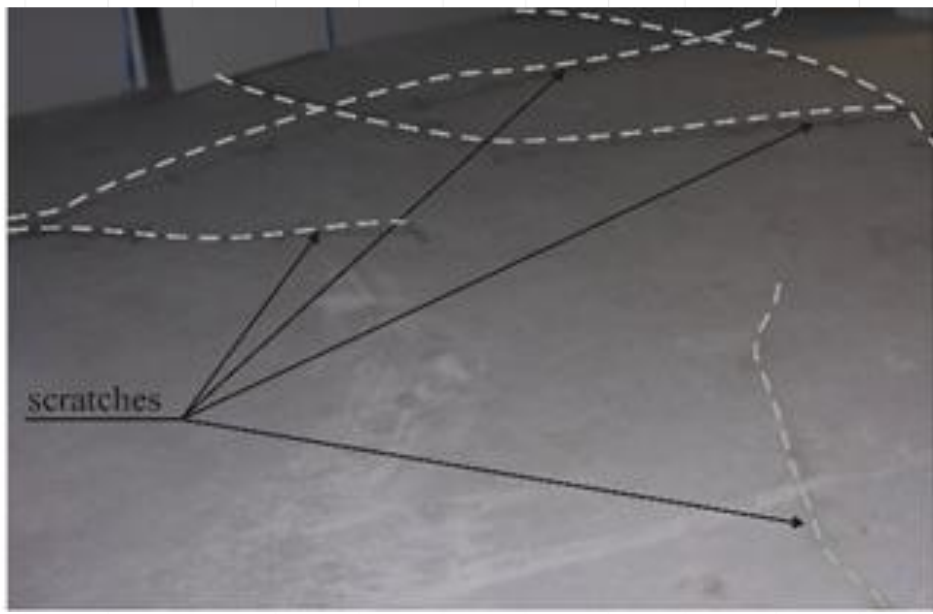
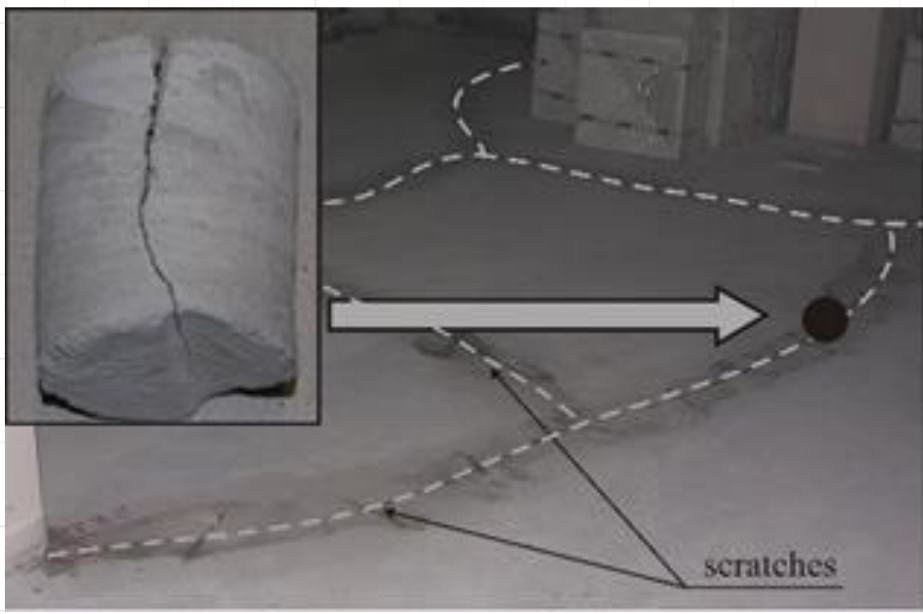

Exemplary view of scratches on the surface of floors tested by the authors along with an approximation of the cut core sample documenting the depth of one of the scratches

Methodology of controlling the technological process of executing floors made of cement-based materials

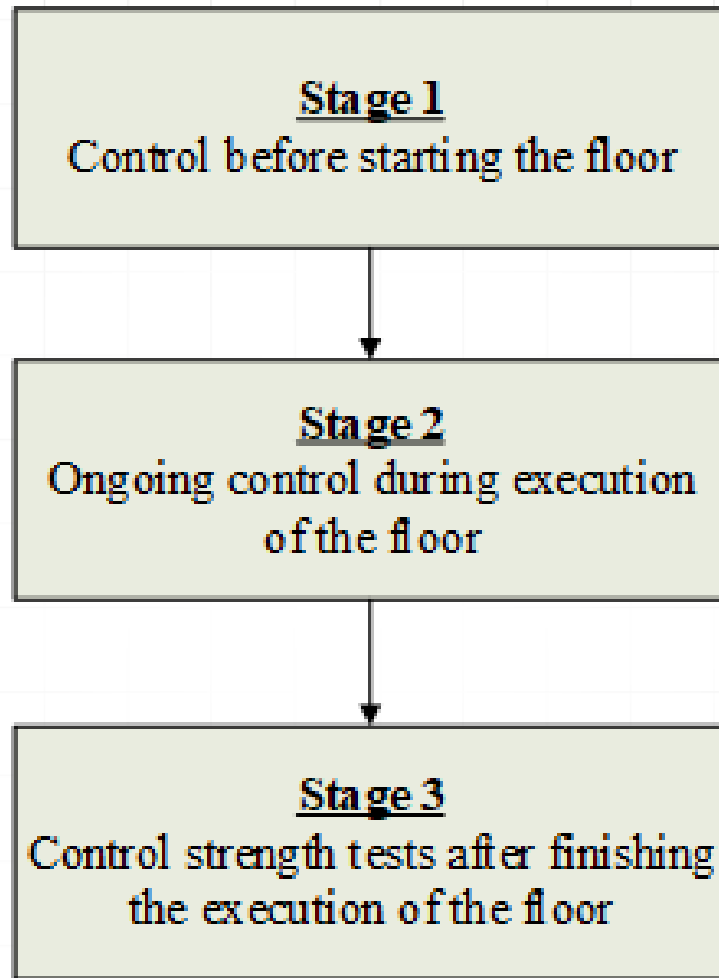

General diagram illustrating the developed methodology

Methodology of controlling the technological process of executing floors made of cement-based materials

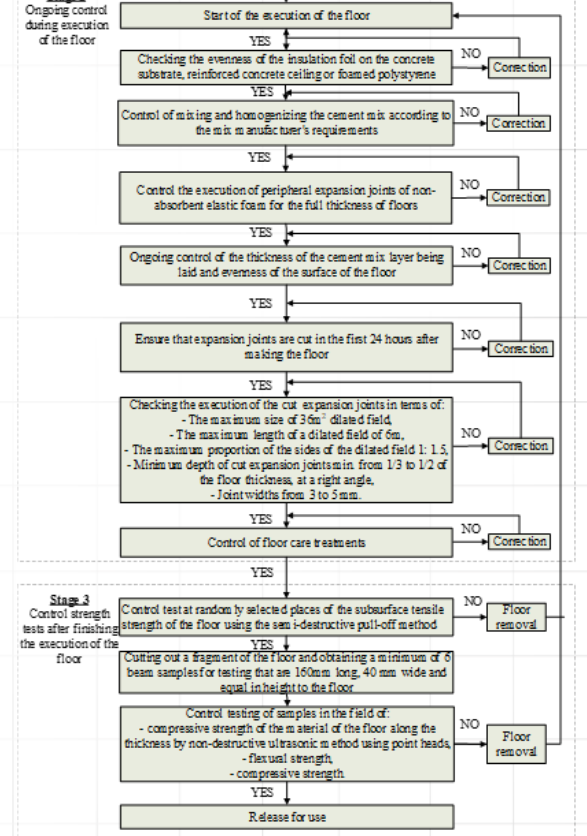
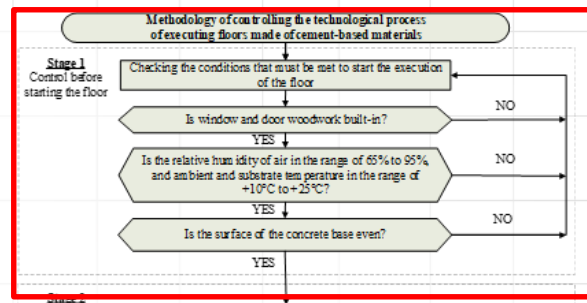
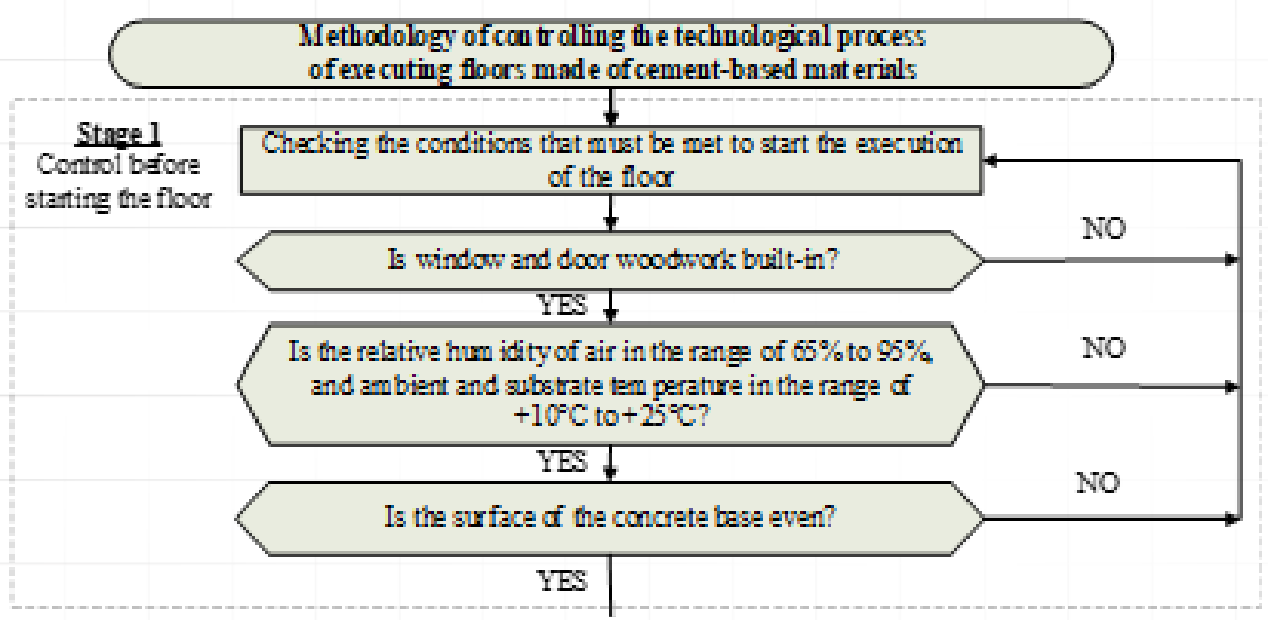

Methodology of controlling the technological process of executing floors made of cement-based materials

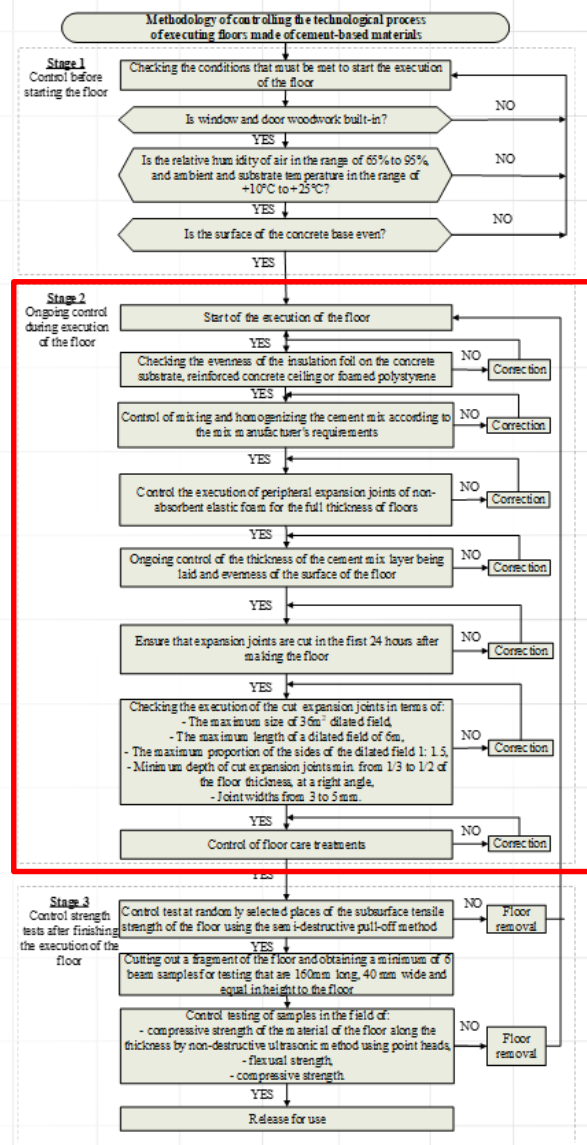
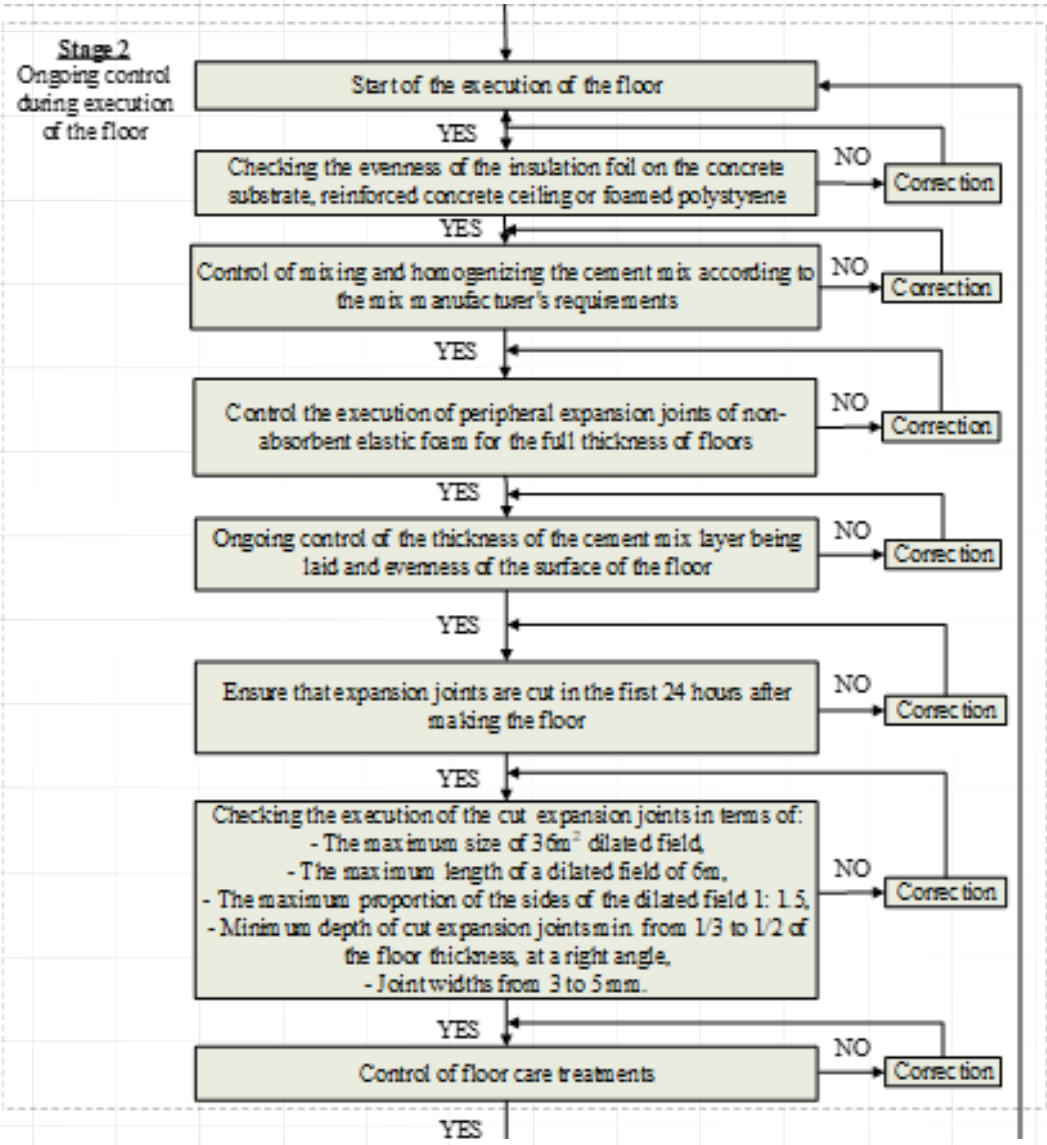

Methodology of controlling the technological process of executing floors made of cement-based materials

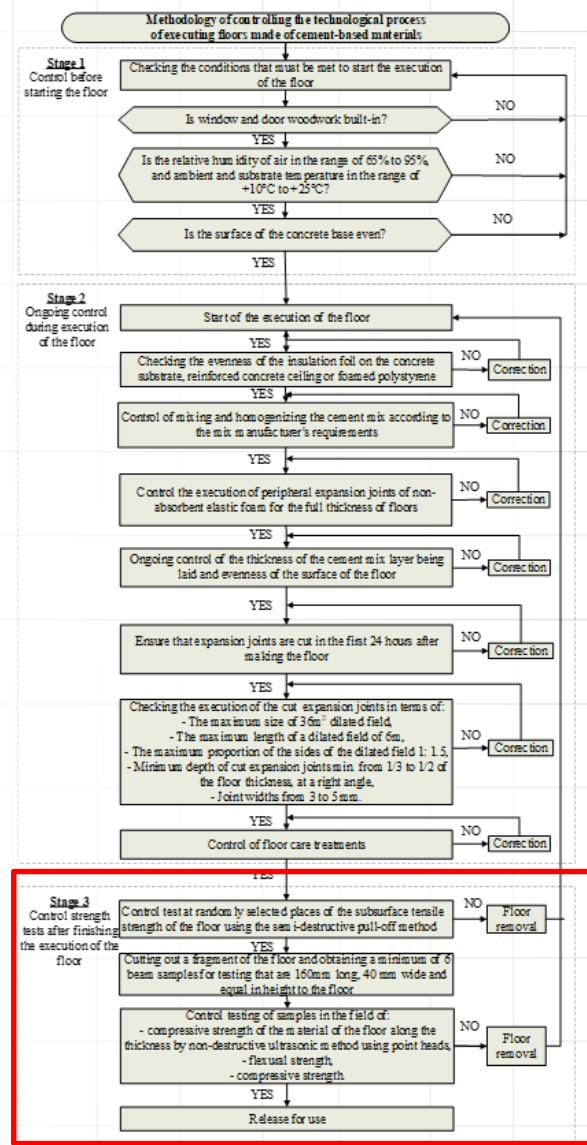
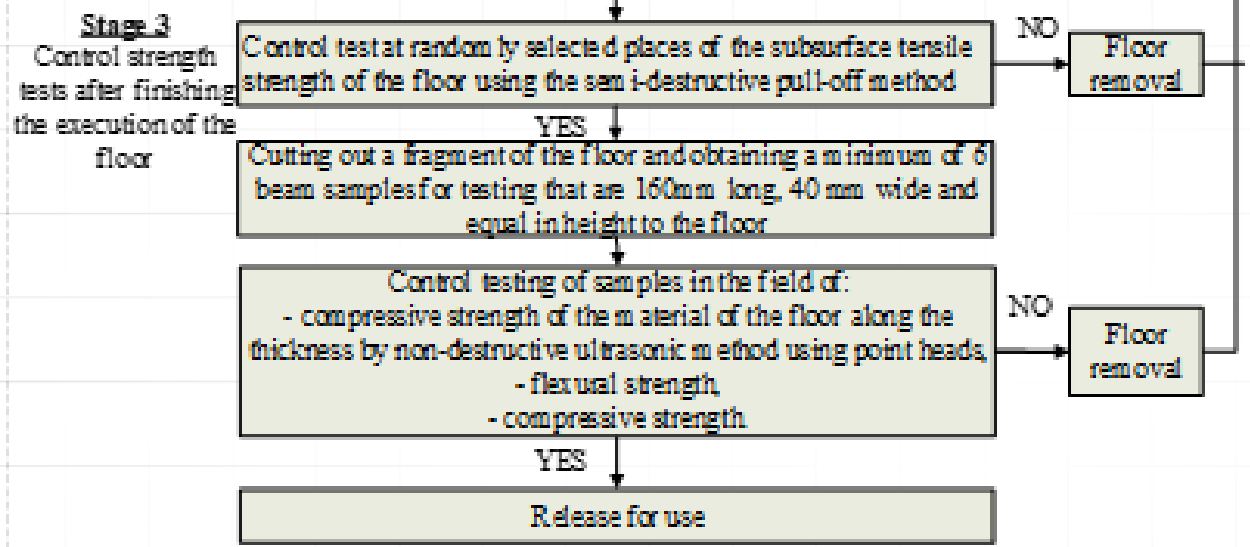

Methodology of controlling the technological process of executing floors made of cement-based materials

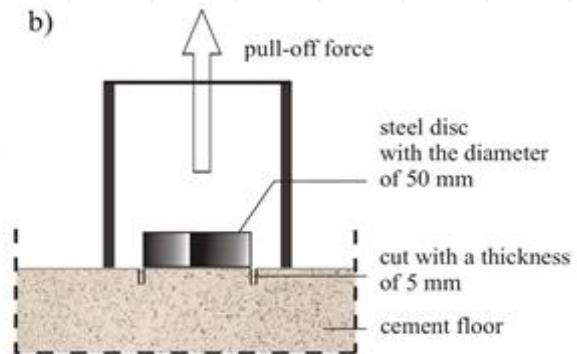

Control of the subsurface tensile strength of the floor using the pull-off method: a) pull-off apparatus; b) scheme of the method; c) view of the glued steel disc; d) view of the floor surface after the pull-off tests

Methodology of controlling the technological process of executing floors made of cement-based materials

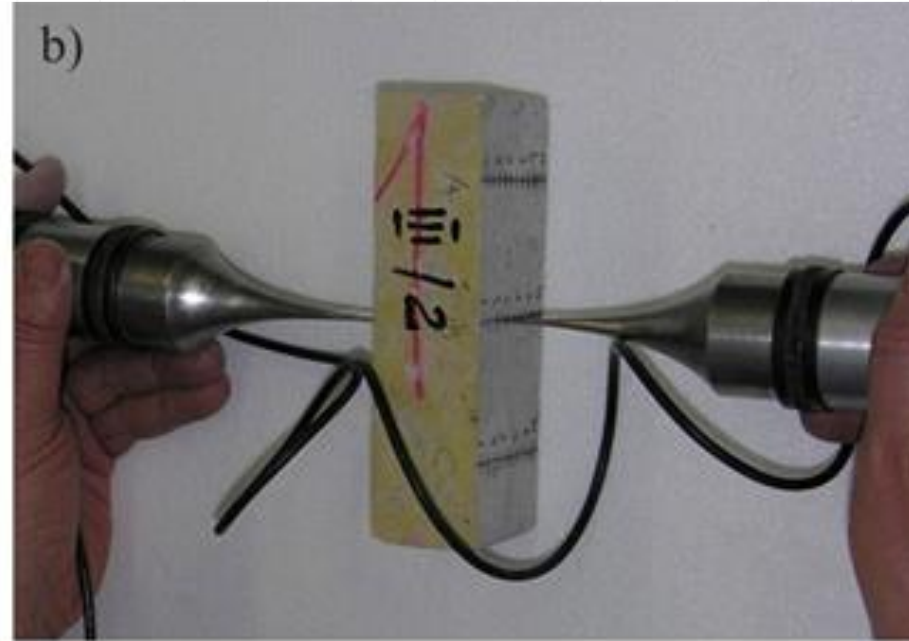

Example view: a) head and probe for ultrasonic testing, b) floor sample tested using the ultrasonic method

Summary

The article presents original and effective methodology of controlling the technological process of executing floors made of cement-based materials. This methodology was developed by the authors for the entire process of cement floor technology, which was missing in the literature. The methodology also indicated the need to use necessary research methods for such control.

Summary

The methodology was developed on the basis of many years of experience of the authors, which was acquired during the examination of the technical condition of floors in various construction objects. The developed methodology was preceded by a synthetic discussion of the most common defects occurring in new floors made of cement-based materials, which are the result of not only the contractor's failure to comply with the relevant requirements, but above all by incorrect, random, unmethodical, and therefore ineffective performance control.

Summary

The proposed methodology should be helpful in construction practice in terms of approaching the ideal situation concerning the execution of floors made of cement-based materials, which should be considered as faultless performance, being beneficial for durability, and also safety of use.

Conclusions

Example of no-ideal situation ;-)





Politechnika
Wroclawska

Floors made of polyurethane materials

Introduction & background

Significant conditions and also technological and technical requirements

Thickness of the overlay	From 4,5 to 6 mm
Environmental conditions	Temperature from +10°C to +40°C
Service conditions	<ul style="list-style-type: none">- Temperature from -40°C to +90°C,- Relative humidity > 85%,- No thermal shocks > +70°C.
Required mechanical properties of the concrete substrate	<ul style="list-style-type: none">- Compressive strength > 25 MPa,- Subsurface tensile strength > 1,5 Mpa.
Application of bonding agent	The epoxy resin filled with quartz sand (grains from 0,4 to 0,7 mm)

Test methodology

The facts about the material:

- overlay with the thickness of 5 mm made of poliurethane-cement,
- substrate with the thickness of 18 cm made of concrete class C20/25.
- the substrate was machine-laid, surface-vibrated and smoothed,
- the operation of the floor is associated with the presence of loaded or unloaded carriage trolleys. They are equipped with polyamide wheels with the size from 50 to 90 mm.



Technical condition of the floor

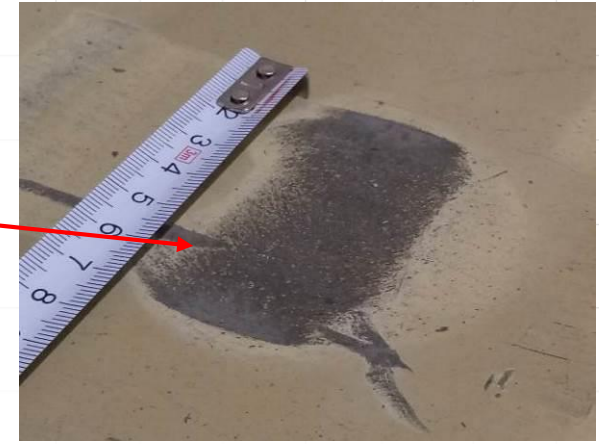
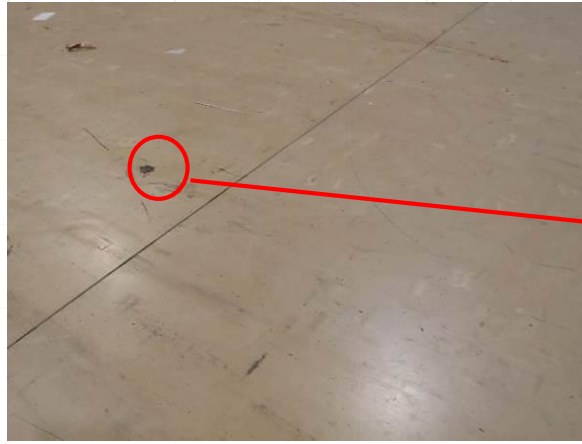

Large number of scratches visible on the surface of the floor

Technical condition of the floor

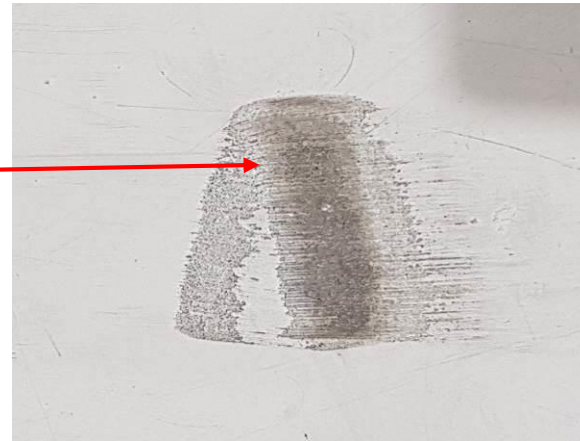
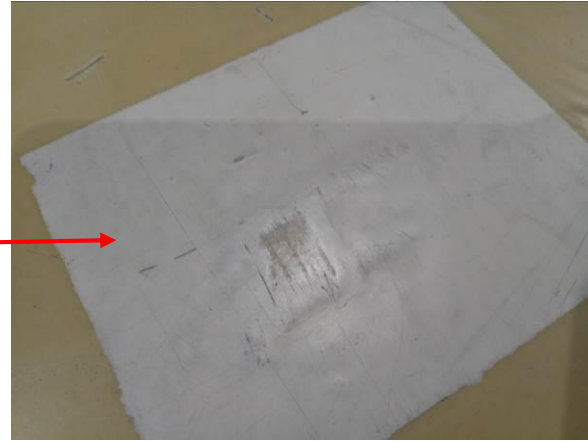
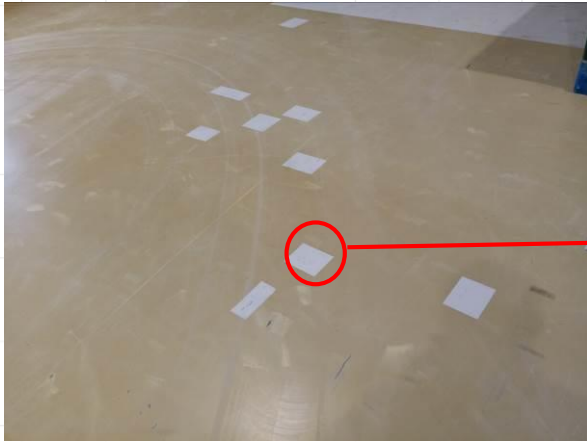

Large number of scratches visible on the surface of the floor

Technical condition of the floor



Other types of voids visible on the surface of the floor

Test methodology

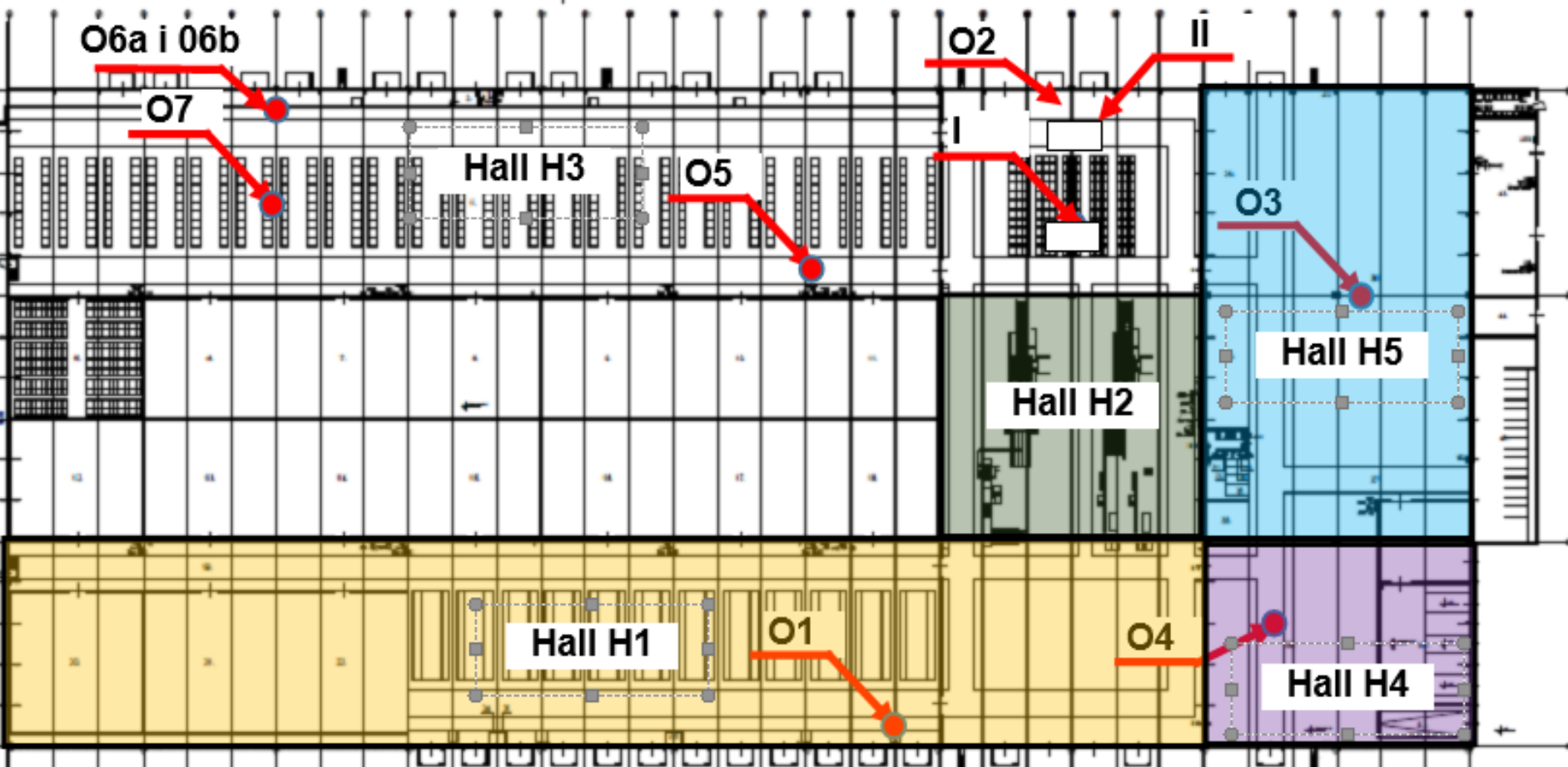

Location of the areas from drilling holes were taken and pull-off tests have been made

Test methodology



Test results and their analysis

Comparison of the average values of the tested properties	Layer designation	
	Overlay	Substrate
Pull-off adhesion strength of the overlay [MPa]:		
- Obtained on the basis of tests	2.48	-
- Required	2.50	-
Compressive strength of the substrate [MPa]:		
- Obtained on the basis of tests	-	53.55
- Required	-	25.00

Test results and their analysis

Comparison of the average values of the tested properties	Layer designation	
	Overlay	Substrate
Abrasion resistance [cm ³ /50 cm ²]:		
- Obtained on the basis of tests	1.85	-
- Required	4.58	-
Thickness [mm]:		
- Obtained on the basis of tests	3.83	175.38
- Required	5.00	180.00

Test results and their analysis

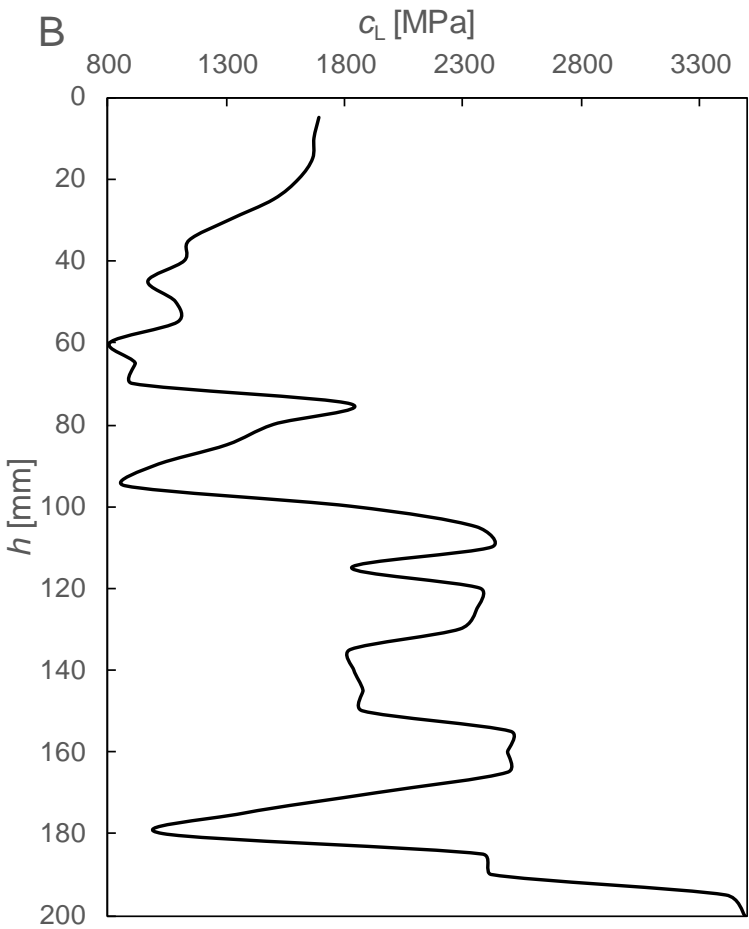
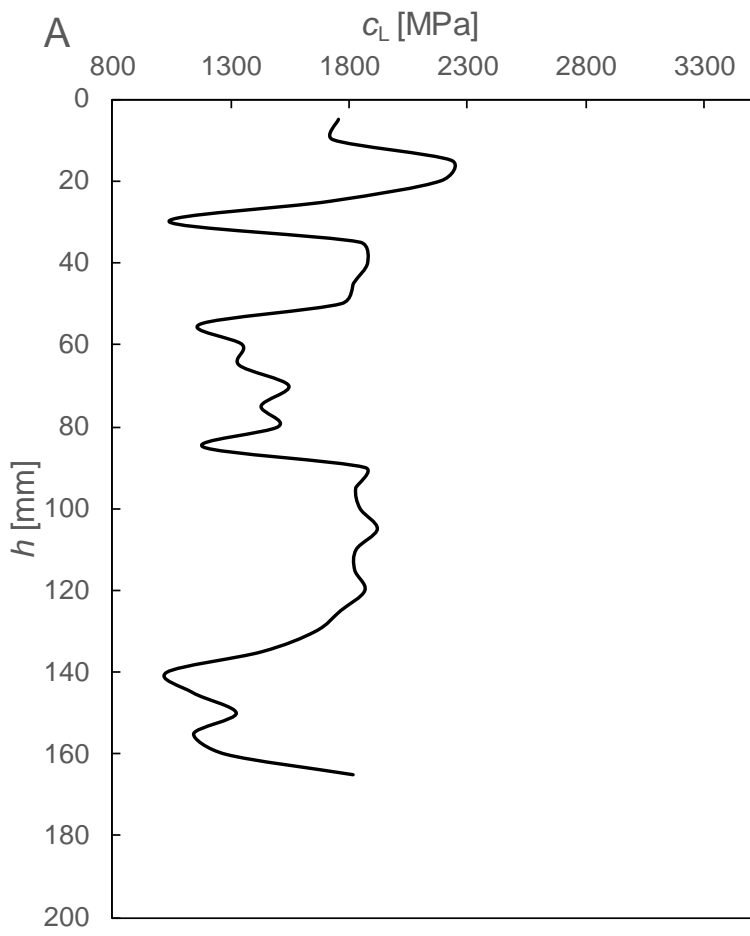

The velocity of the longitudinal ultrasonic wave c_L along the thickness h of the specimens obtained from floors

Test results and their analysis

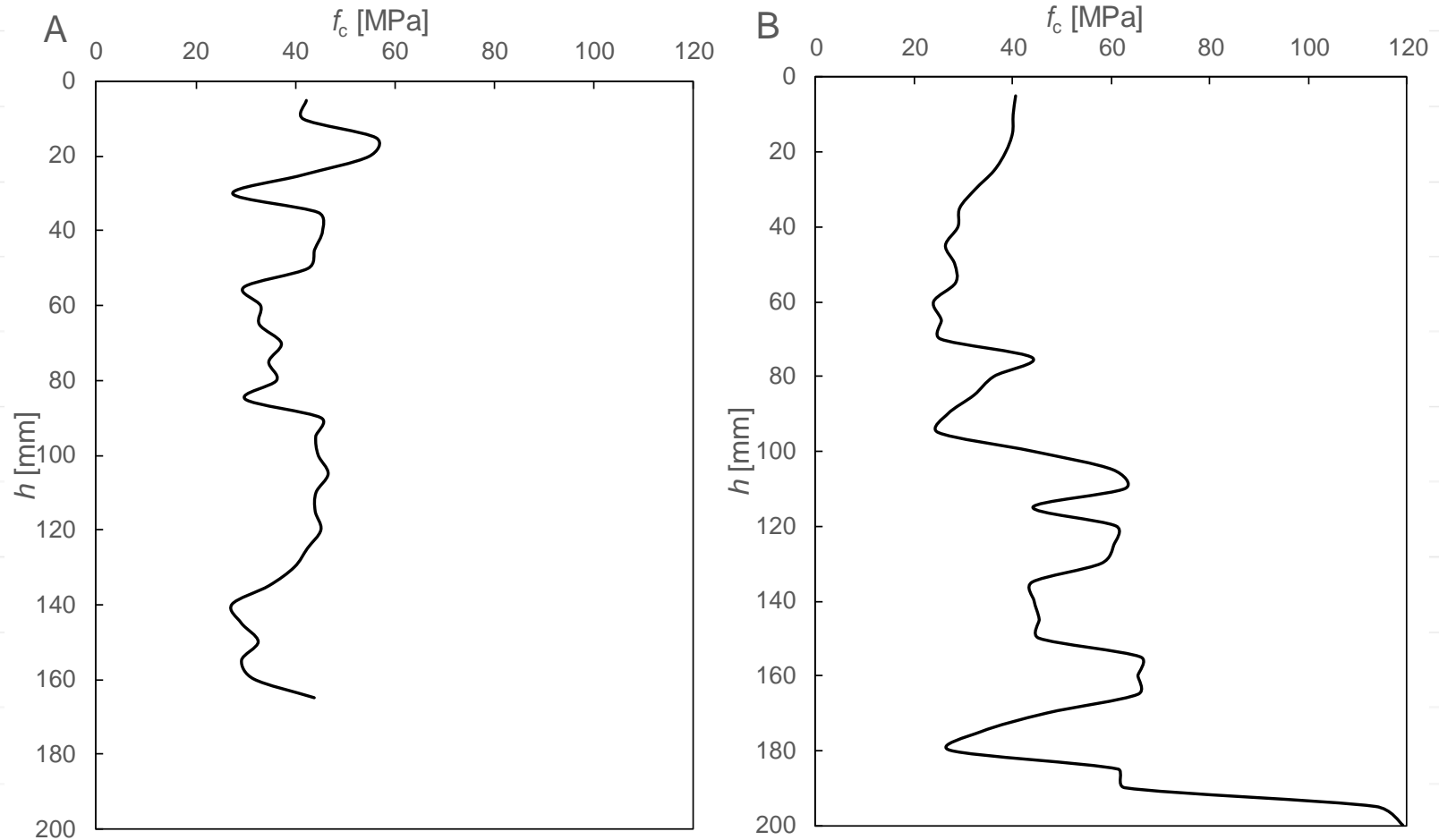

The course of compressive strength f_m of cement mortar along the thickness h of the specimens taken from floors

Test results and their analysis

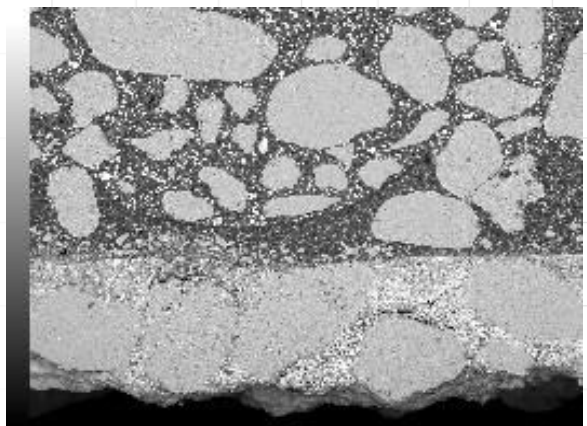
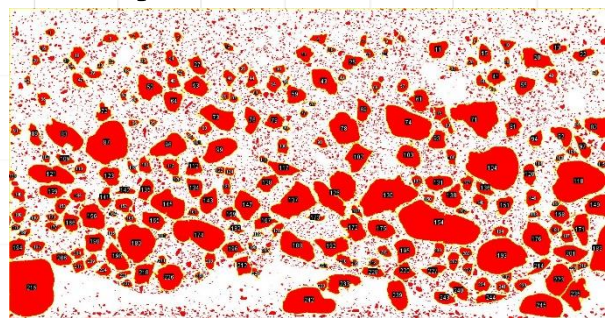
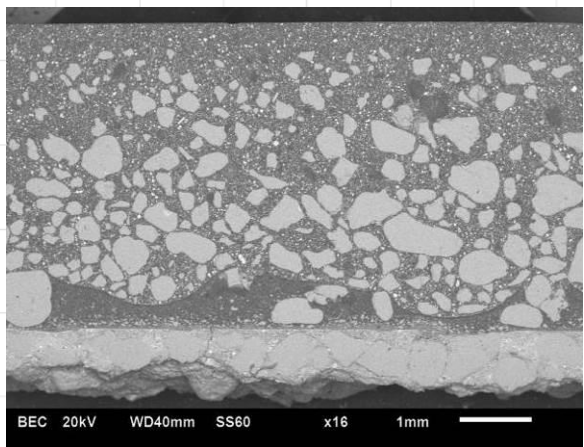

IMG1

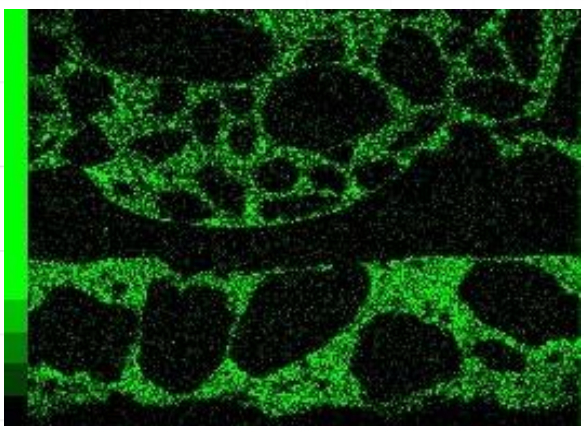

Ca K

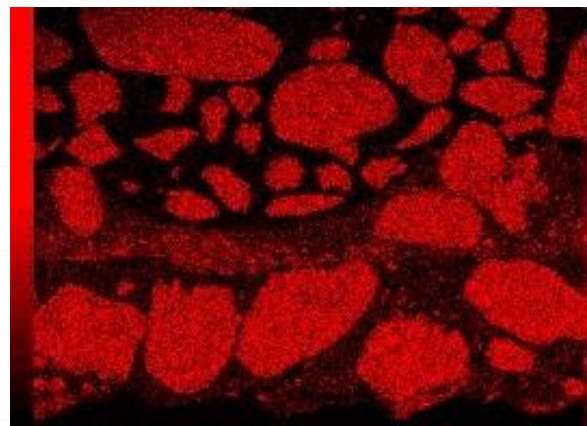

Si K

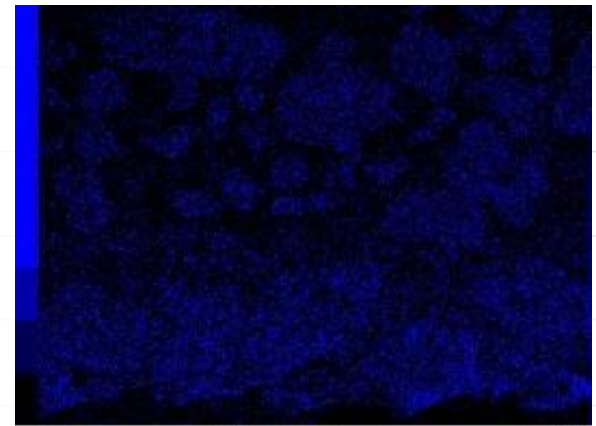

O K

Microstructural analysis

Test results and their analysis

Chemical analysis

Element	Concrete substrate [%]	Bonding agent made of epoxy resin [%]	Overlay made of polyurethane-cement [%]
O	45.04	43.68	65.14
Mg	1.75	-	-
Al	5.31	-	-
Si	18.59	56.32	6.58
K	1.71	-	-
Ca	25.73	-	25.94
Ti	-	-	2.34
Fe	1.89	-	-

Test results and their analysis

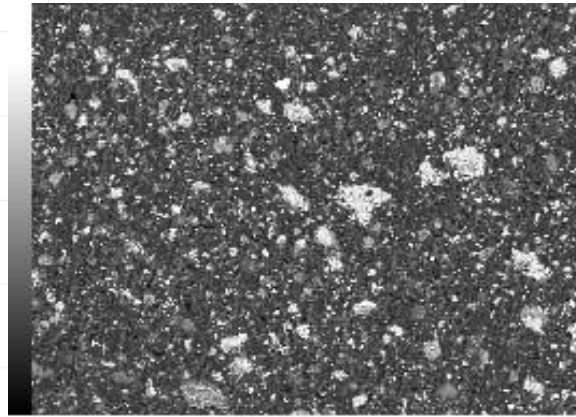

200 μm

IMG1

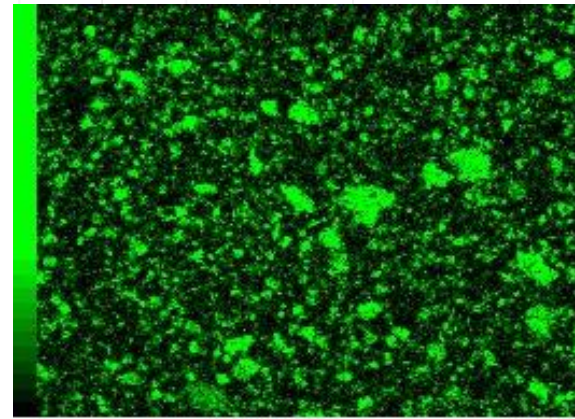

200 μm

Ca K

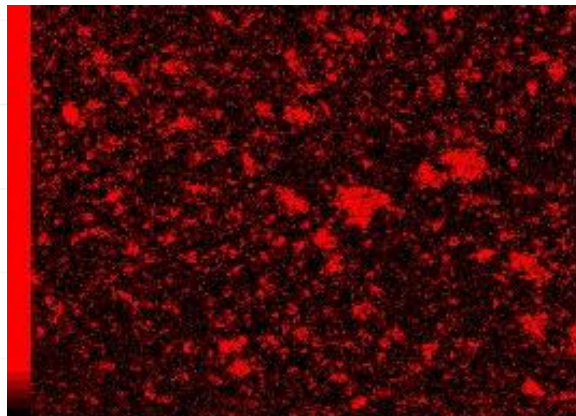

200 μm

Si K

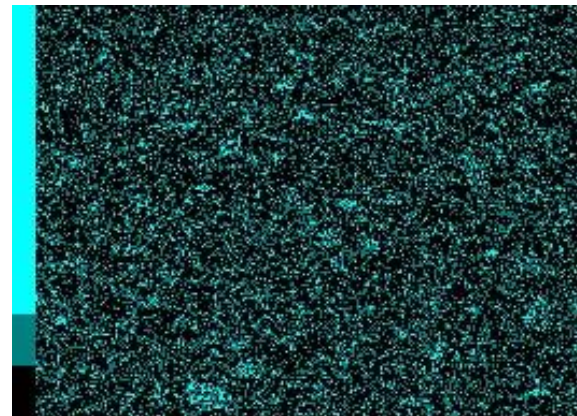

200 μm

O K

Chemical analysis of the material of the overlay

Test results and their analysis



Test results and their analysis

Time[s]	T_1^* [°C]	T_2^{**} [°C]	$\Delta T = T_2 - T_1$ [°C]
3	71,2	83,6	12,4
6	88,7	95,2	6,5
9	97,4	102,8	5,4
12	121,1	124,7	3,6
15	130,6	131,6	1,0
18	134,1	140,6	6,5
21	146,8	149,0	2,2



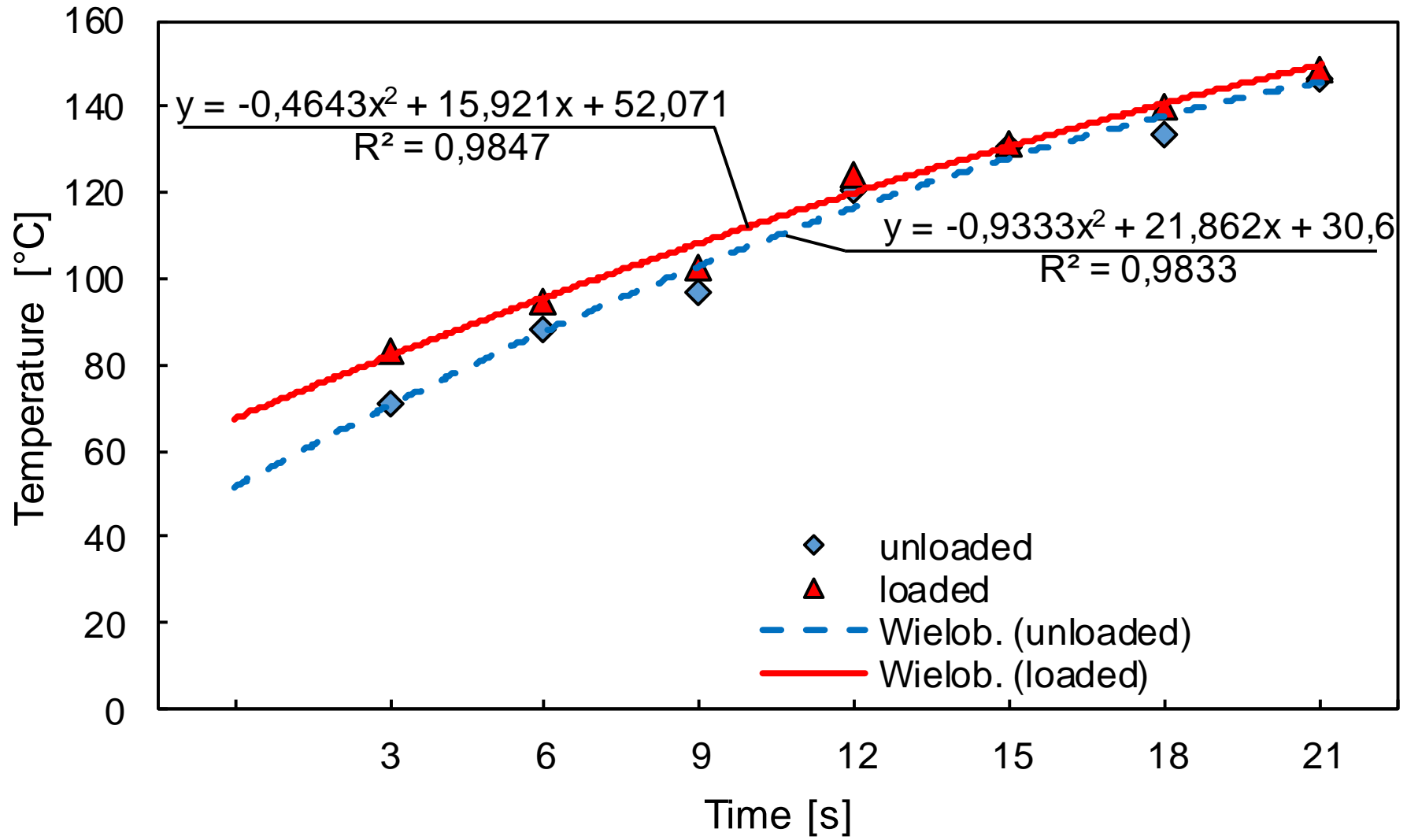

* T_1 – temperature of the surface of the overlay **po próbie buksowania koła napędowego nieobciążonego wózka widłowego**

** T_2 – temperature of the surface of the overlay **po próbie buksowania koła napędowego wózka widłowego obciążonego paletą o wadze około 500 kg**







Test results and their analysis



Test results and their analysis

3	 A cylindrical specimen, likely a fiber or filament, is shown under a magnifying glass. The specimen has a textured, fibrous appearance. A checkmark is drawn next to it, indicating a successful or acceptable result.	 A cylindrical specimen, similar to the one in the first row, is shown under a magnifying glass. The specimen has a textured, fibrous appearance.
6	 A cylindrical specimen, similar to the one in the first row, is shown under a magnifying glass. The specimen has a textured, fibrous appearance.	 A cylindrical specimen, similar to the one in the first row, is shown under a magnifying glass. The specimen has a textured, fibrous appearance.
9	 A cylindrical specimen, similar to the one in the first row, is shown under a magnifying glass. The specimen has a textured, fibrous appearance.	 A cylindrical specimen, similar to the one in the first row, is shown under a magnifying glass. The specimen has a textured, fibrous appearance.

Test results and their analysis

15		
18		
21		

Test results and their analysis

Time the operation of the well [s]	Pull-off adhesion f_b in the place of the operation of the whell [MPa]	Pull-off adhesion f_b outside the place of the operation of the whell [MPa]	Redusction of the pull-off adhesion [%]
Unloaded			
3	0,87	1,51	42,4
12	0,85	1,17	27,4
21	1,00	1,60	37,5
Loaded			
3	1,44	1,64	12,2
12	1,40	1,84	23,9
21	1,74	2,34	25,6

Conclusions

The causes that led to the occurrence of such numerous and large defects of the tested floors involved significant errors made both at the stage of preparing and laying the cement mix, as well as at the stage of executing the floors, namely:

- the execution of too thin overlay in relation to the designed thickness,
- no resistance for thermal shock over 70°C.



Politechnika
Wroclawska

Use of waste wool in cement-based materials

Greenhouse soilless cultivation on specially adapted substrates is currently used in order to increase yielding intensity in horticulture, such as the mineral horticultural wool with hydrophilic properties.



After being used for one year, it becomes waste: at present is not in any way managed,

- it is stored on legal landfills, as well as illegally in forest areas, wasteland and fields,
- the amount of horticultural mineral wool waste is considerable, as every year around 100m³ of it is created from 1 ha of production area,
- it amounts to around 500,000 m³ annually in the entire European Union.

Although mineral horticultural wool is a natural product, which is produced from igneous rocks and is characterized by high water absorption and good physicochemical properties, the problem of its utilization and management has not been solved.



Mineral wool



**Post-cultivation
(used) mats
in a waste stockpile**

Photos taken from:

http://ec.europa.eu/environment/life/project/Projects/index.cfm?fuseaction=home.showFile&rep=file&fil=LIFE10_ENV_PL_000661_LAYMAN.pdf

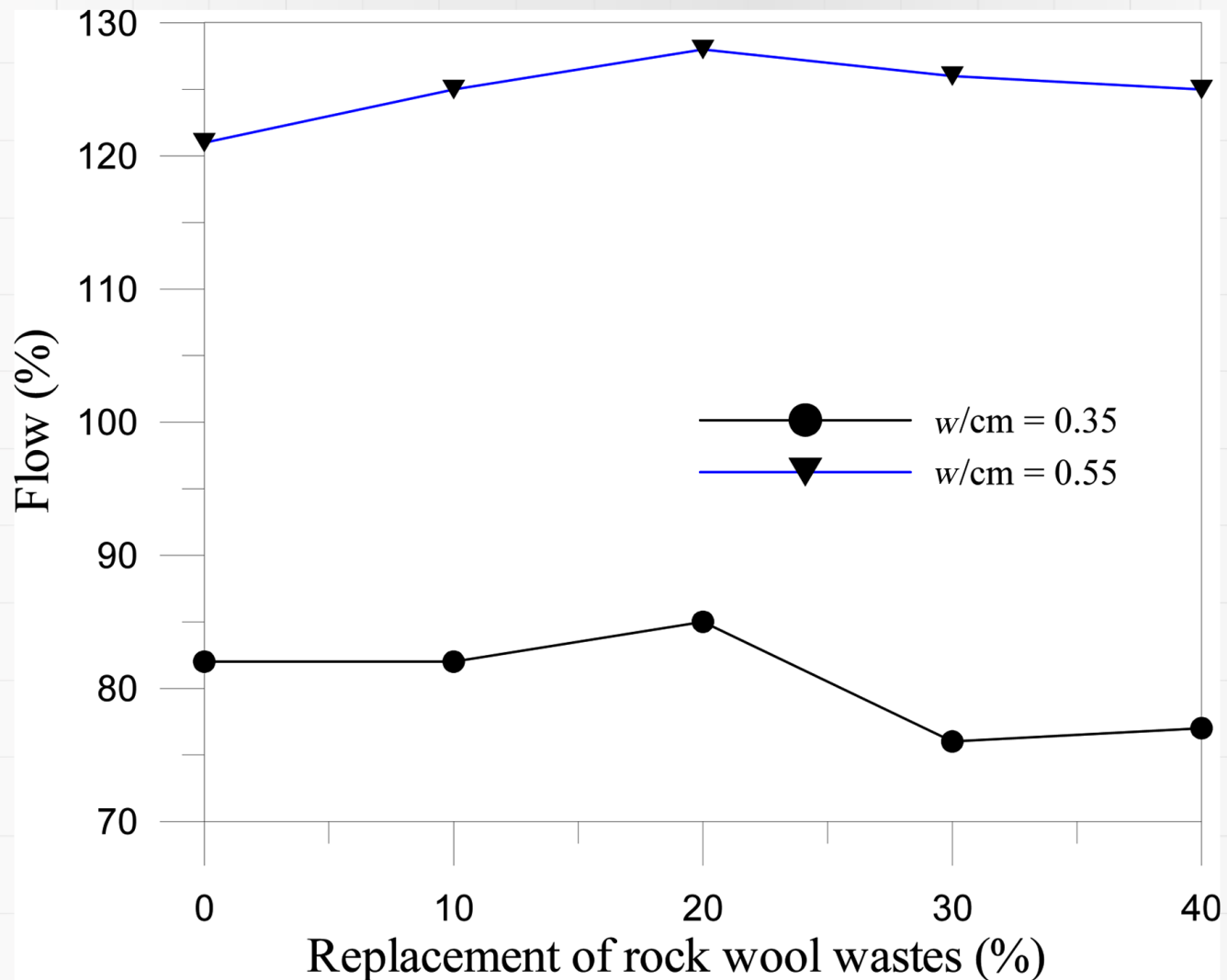

Photo taken from: Lin, W. T., Cheng, A., Huang, R., Wu, Y. C., & Han, T. Y. (2013). AC Rock wool wastes as a supplementary cementitious material replacement in cement-based composites. *Comput. Concr*, 11.

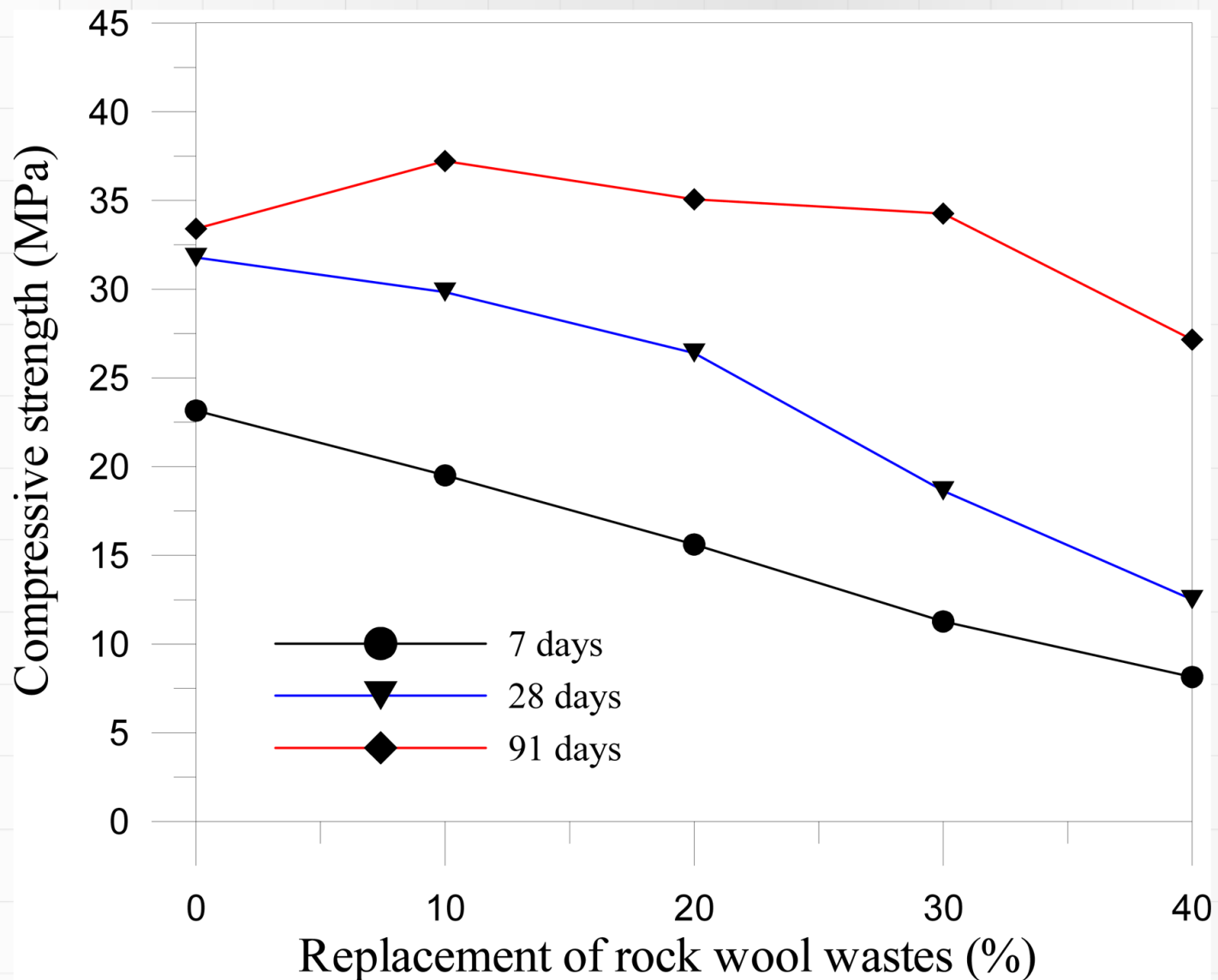

Photo taken from: Lin, W. T., Cheng, A., Huang, R., Wu, Y. C., & Han, T. Y. (2013). AC Rock wool wastes as a supplementary cementitious material replacement in cement-based composites. *Comput. Concr*, 11.

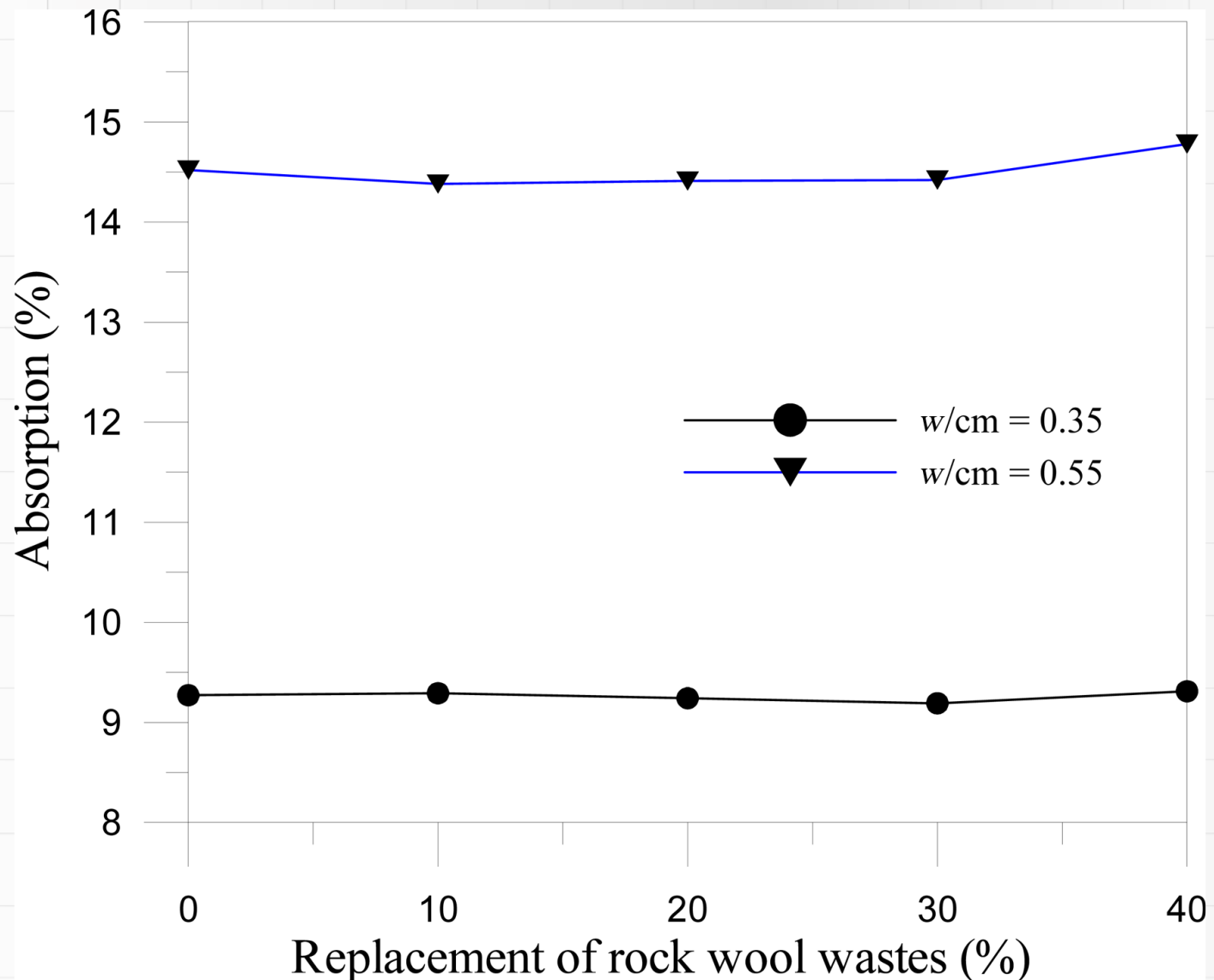

Photo taken from: Lin, W. T., Cheng, A., Huang, R., Wu, Y. C., & Han, T. Y. (2013). AC Rock wool wastes as a supplementary cementitious material replacement in cement-based composites. *Comput. Concr*, 11.

Materials:

- waste horticultural mineral wool was prepared for testing by crushing, and then drying at a temperature of 105°C until a constant mass was obtained. This was followed by mechanical grinding.
- the water absorptivity of this prepared wool was equal to 240%.
- tap water and CEM I 42.5 R Portland cement were used coefficient of water/binder was equal to 0.400
- the prepared waste horticultural mineral wool, was dosed into the mixing water,
- the cement was added and the mix was stirred for about 2 minutes in a mechanical mixer.



View of the waste horticultural mineral wool after grinding and before being added to the mixing water (left) and after mixing the powdered material with mixing water (right)

Compositions of the cement paste series

Designation of paste series	Mass share of waste horticultural mineral wool (in % of filler mass)	Water (g)	Cement (g)	W/C ratio (-)	Wool (g)
R	0 %	400	1000	0,400	0
2	2 %	400	980	0,408	20
4	4 %	400	960	0,417	40
6	6 %	400	940	0,425	60
8	8 %	400	920	0,435	80

Testing:

- Vicat apparatus was used to test the rheological properties of the mix,
- 11 cylindrical samples with an area of 1000mm² and a height of 10mm were made,
- the paste was laid in steel molds in two layers,
- after placing the paste in the molds, it was shaken in order to be compacted,
- for the first 48 hours the specimens were stored in the molds in a climatic chamber with an air temperature of 20 ± 2 °C and a relative humidity of 65%,

Testing:

- after 48 hours, the specimens were taken out of the molds and placed in water, where they were then stored for a further 26 days at an air temperature of 20 ± 2 °C,
- from each series, 5 specimens were used to test the compressive strength after 28 days,
- from each series 5 specimens were used to test the compressive strength after 120 days,
- 1 sample was used to assess the physical properties of the composite after 120 days.



View of the waste horticultural mineral wool specimens of cement paste stored in water for 28 days (left) and a specimen subjected to the compression tests (right)

Depth of needle penetration in
the cement paste [mm]

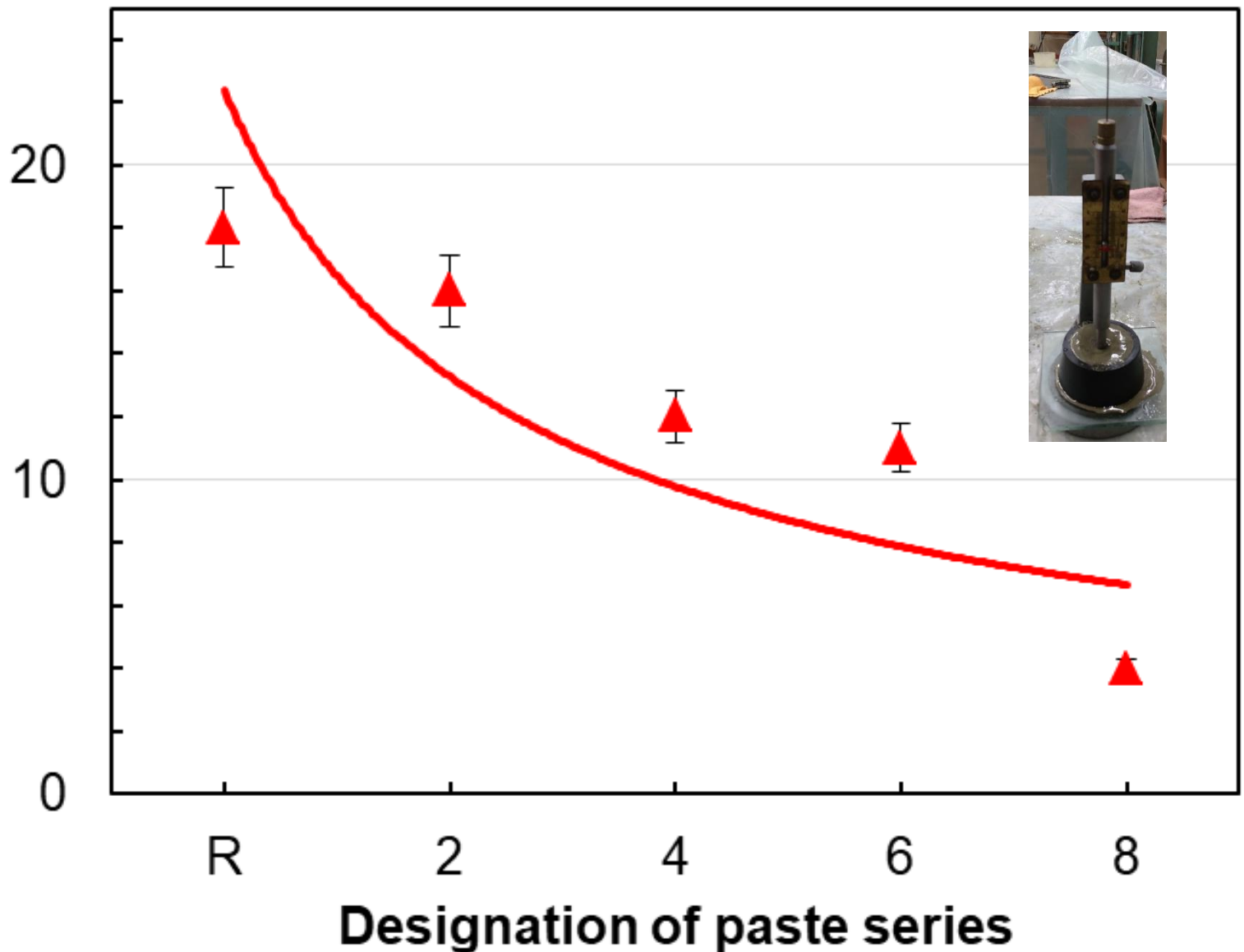

Investigations of the rheological properties of particular series of cement paste mixes: influence of the addition of the waste horticultural mineral wool in the cement paste on the depth of needle penetration

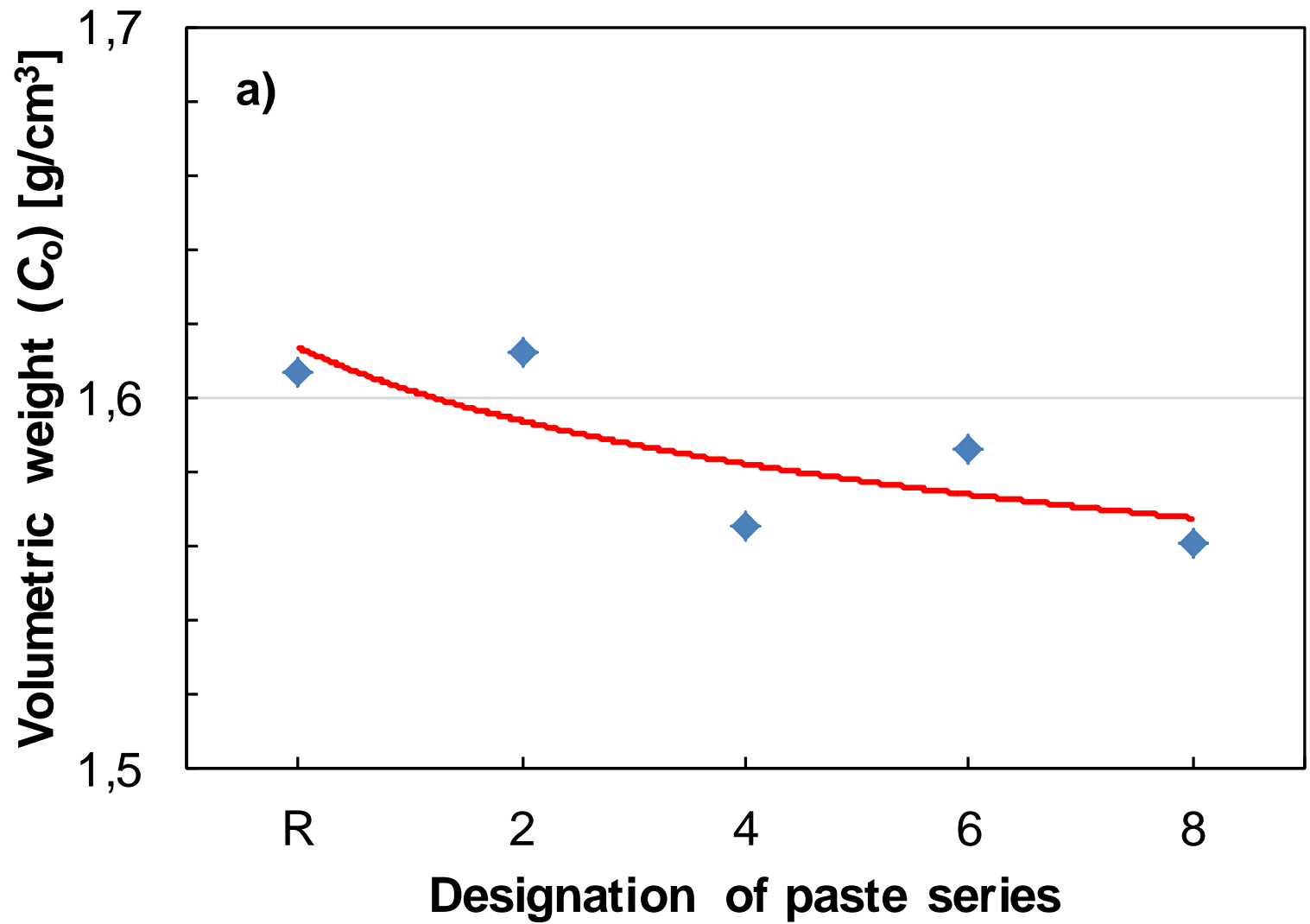

Volumetric weight (density) of the individual series of pastes

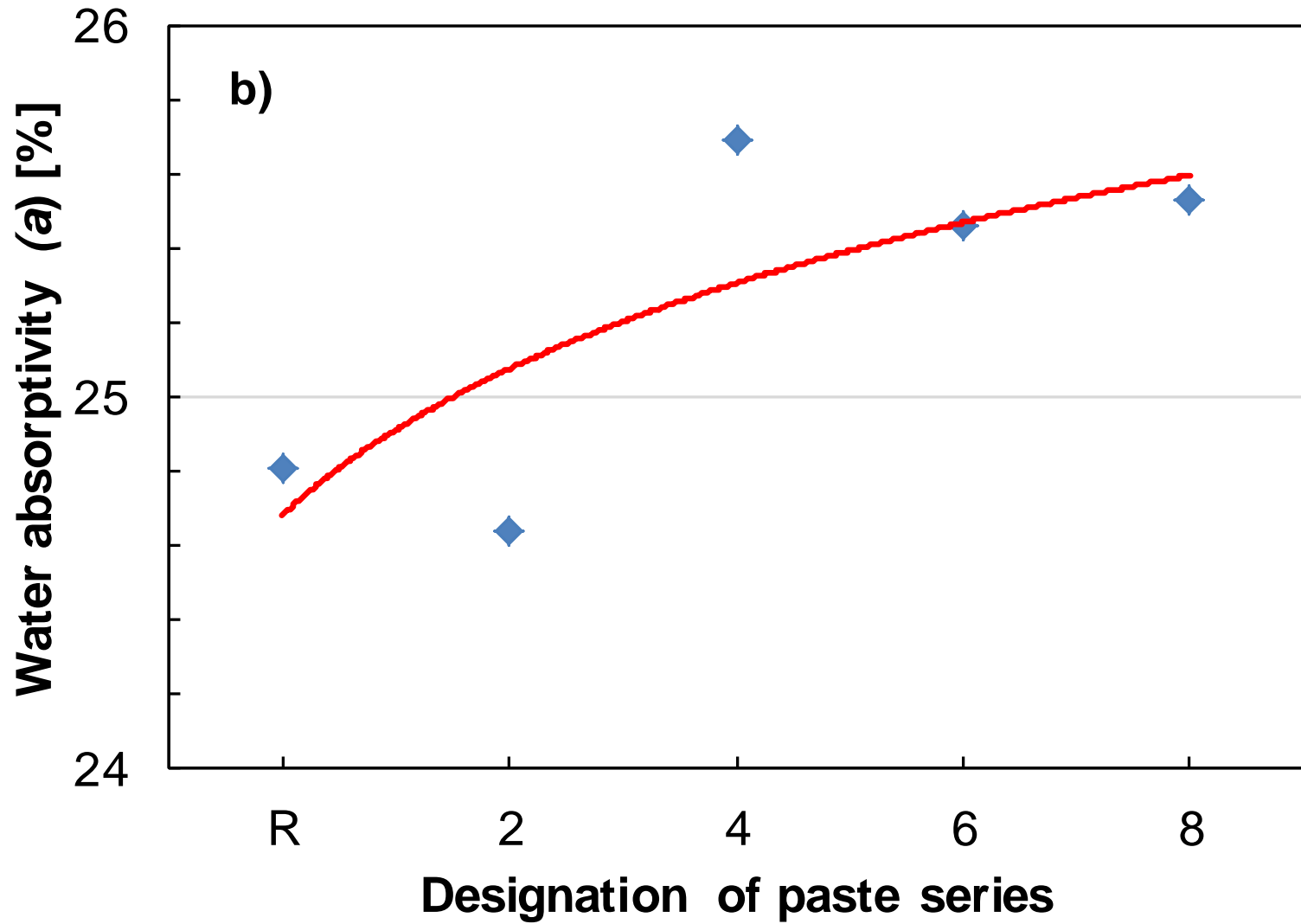

Water absorptivity of the individual series of pastes

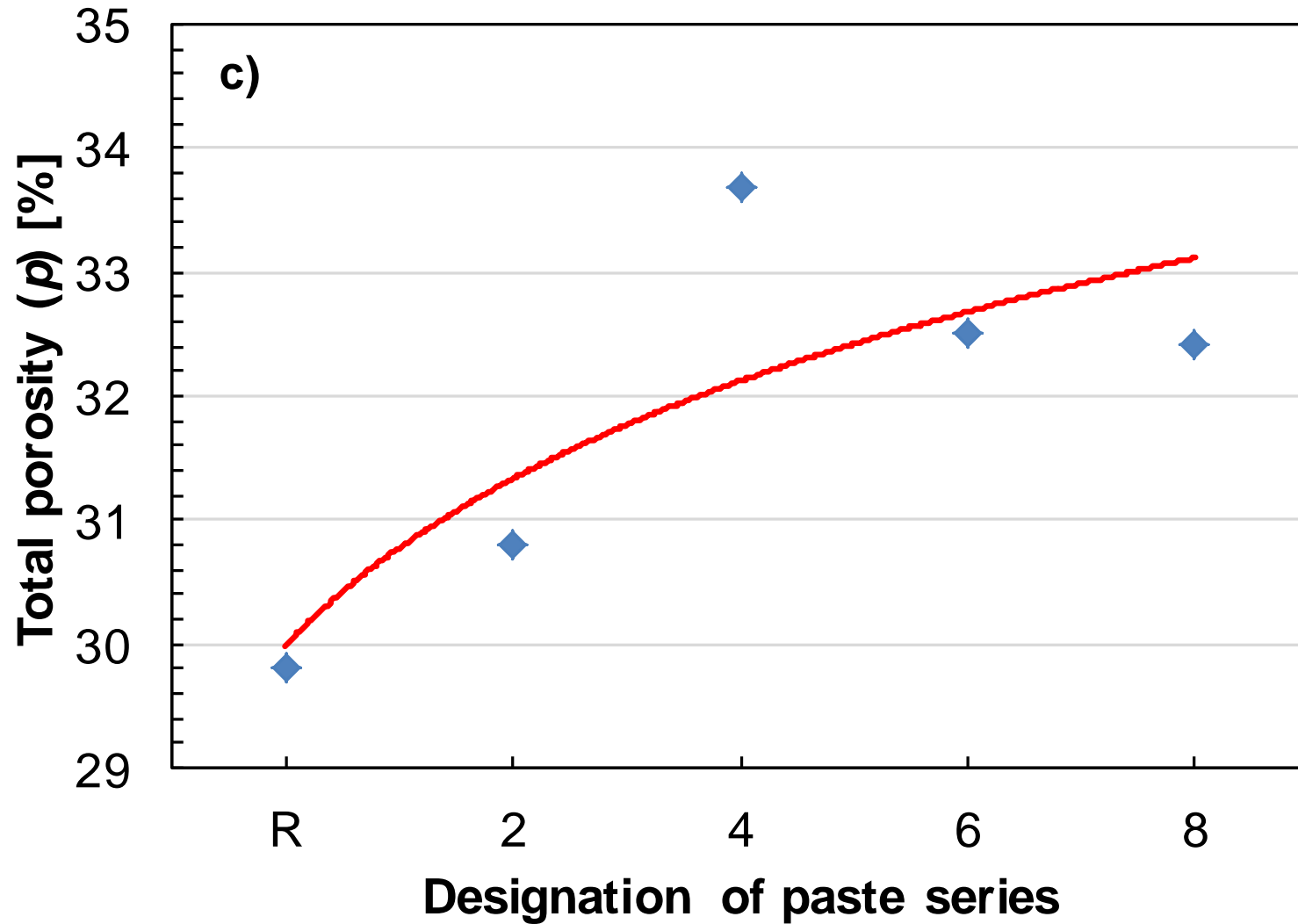

Total porosity of the individual series of pastes

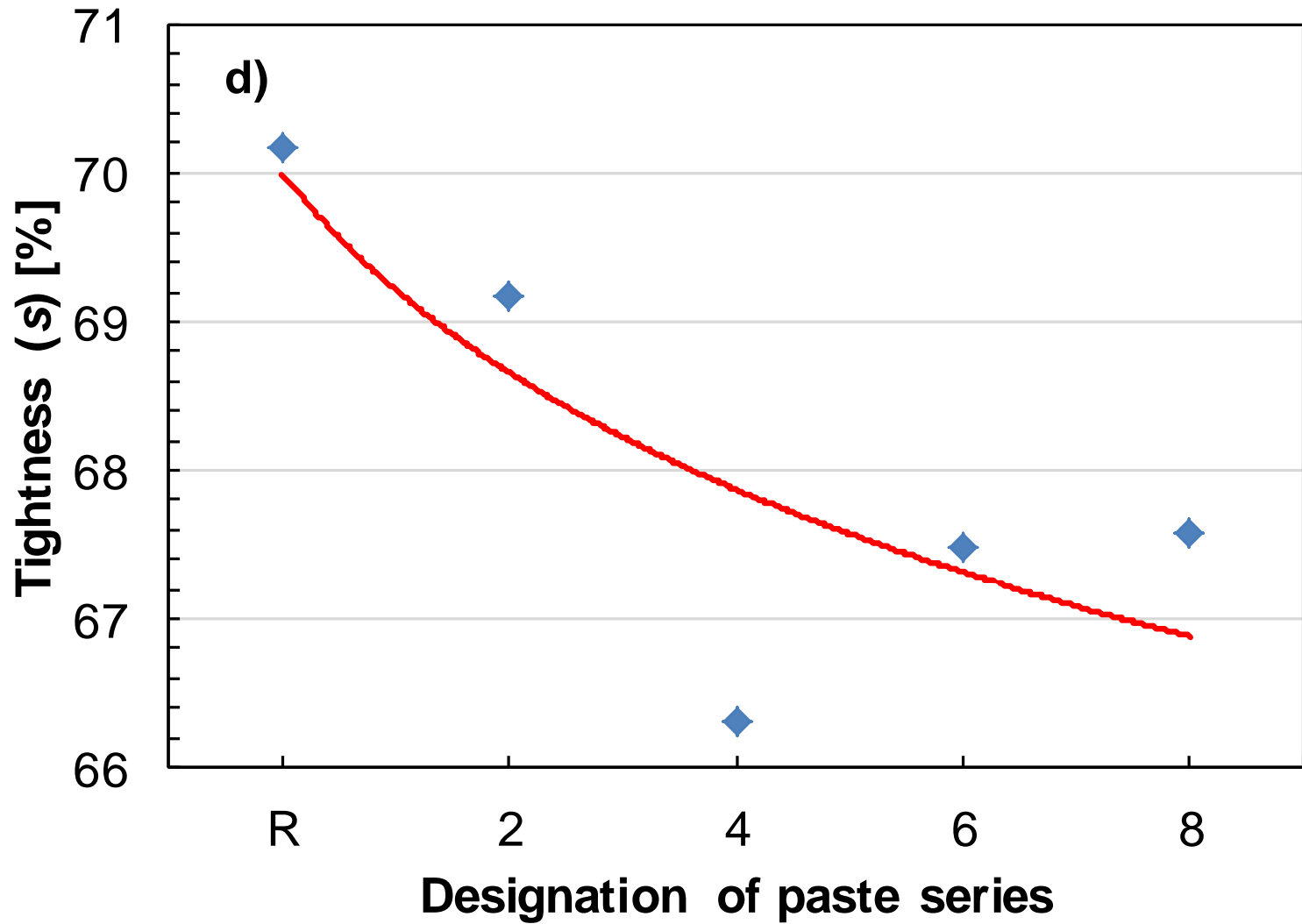

Tightness of the individual series of pastes

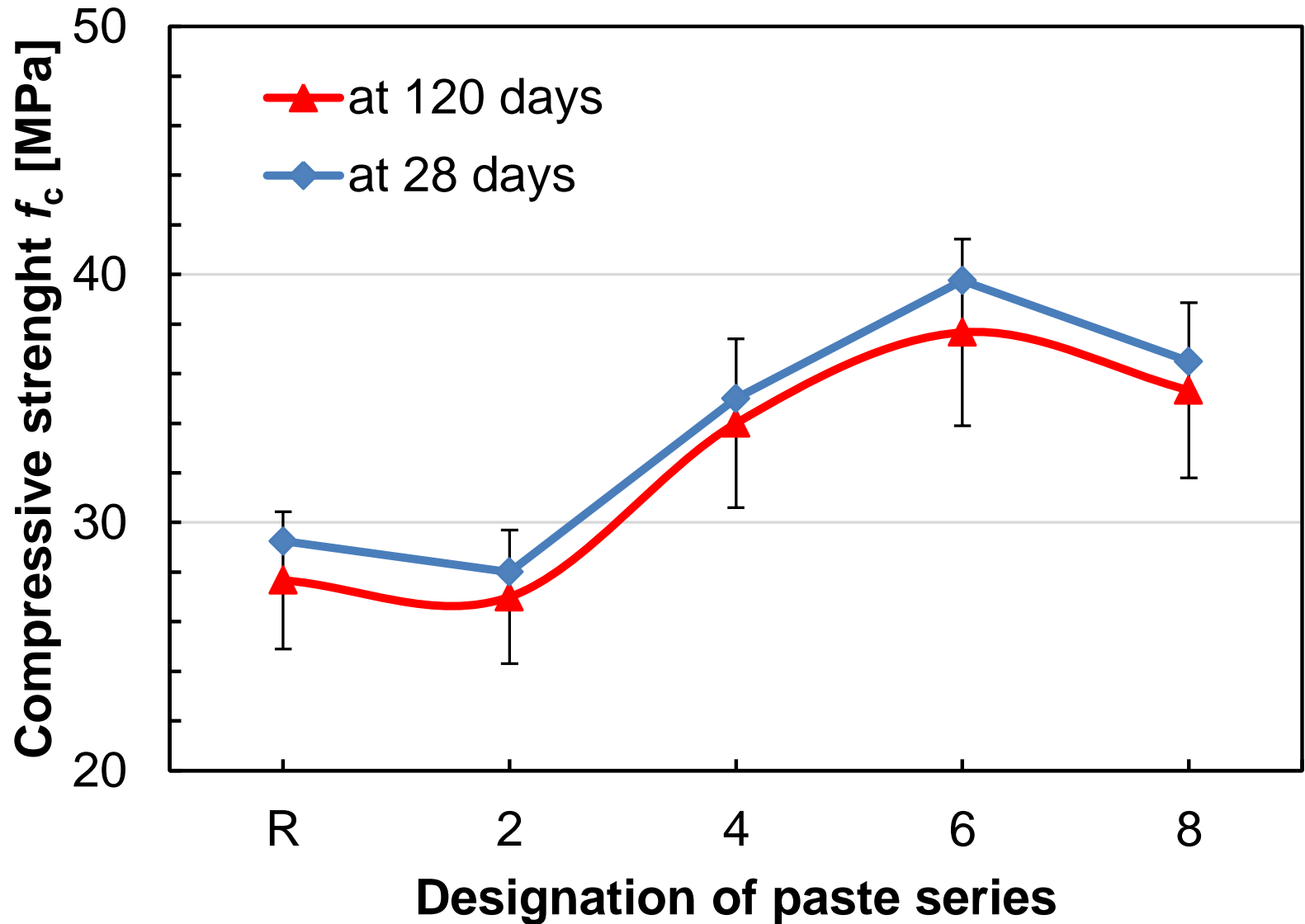

Compressive strength of the individual series of pastes



Politechnika
Wroclawska

Modification of materials using nanoparticles

Introduction & background

Cement composite

should be understood as a material made up of a minimum of two components: a cement matrix and aggregate, in such a way that it should have properties superior to the components taken separately.

Functional properties of cement-based overlays

Functional properties

the properties determined by function of the overlay

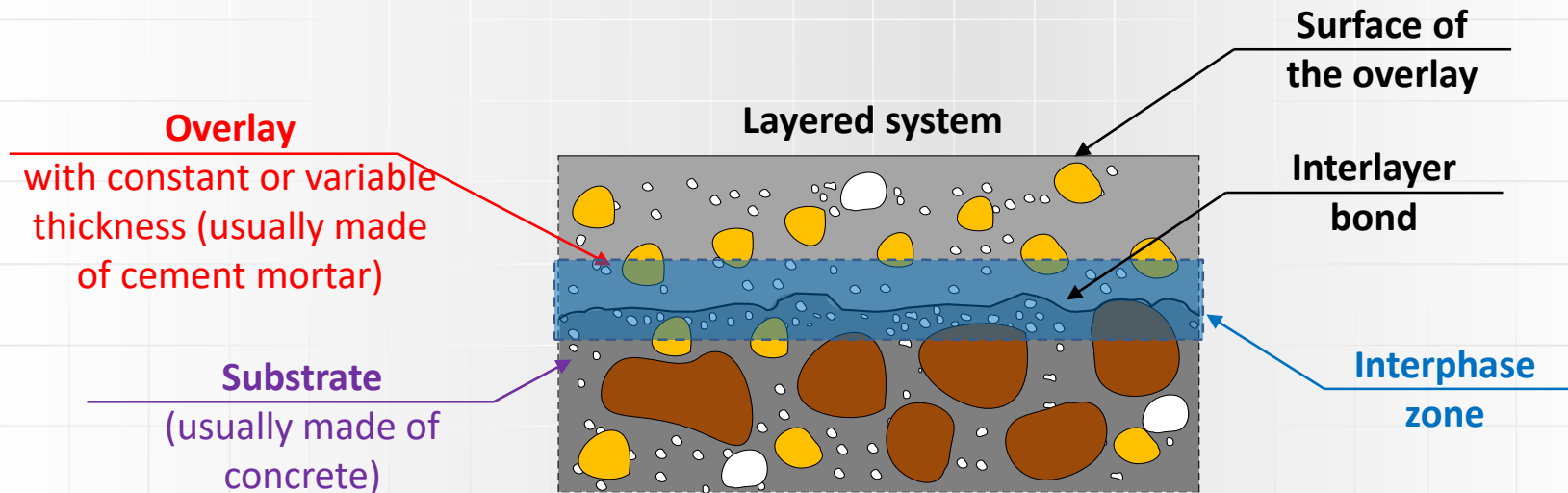

Cement-based overlays are used in floors in:

- residential and public buildings,
- industrial buildings, e.g. in multi-seat garages.



An example of a floor view in: a) a residential building, b) a multi-station garage

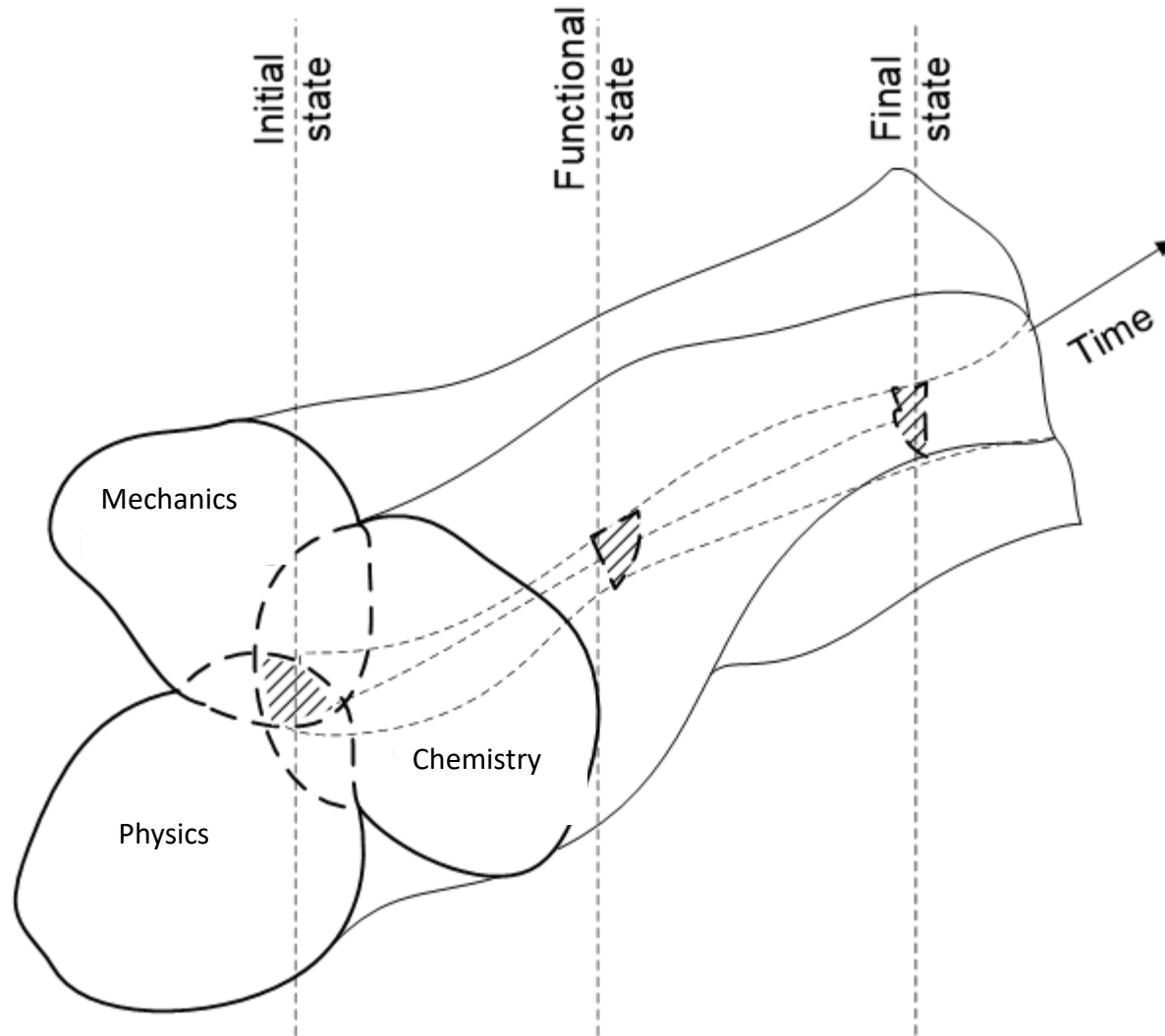

Functional properties as the combination of chemical, physical and mechanical state

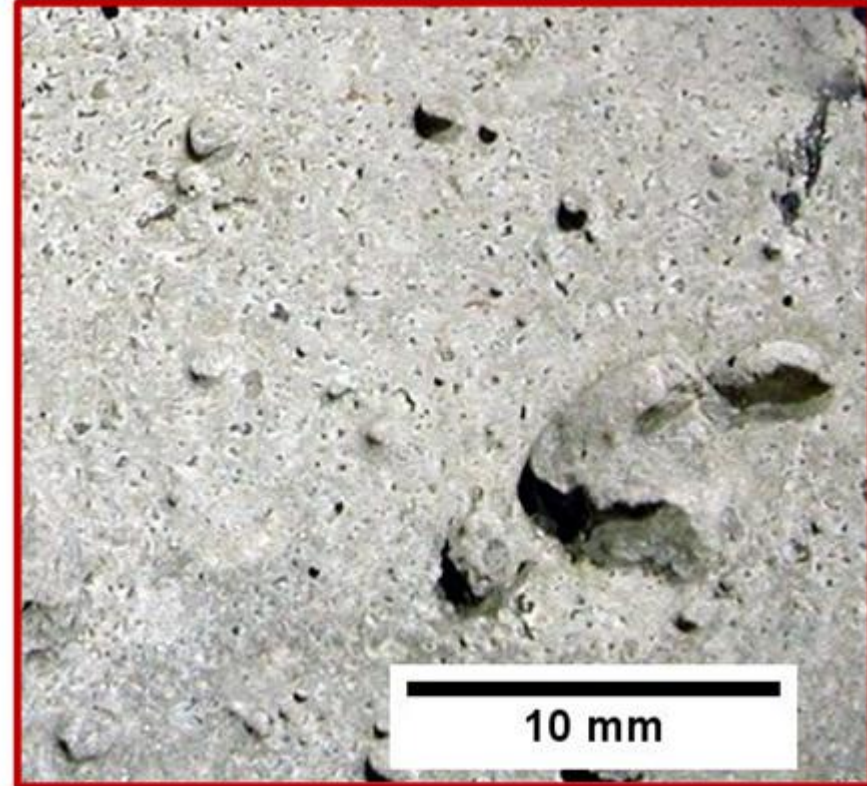
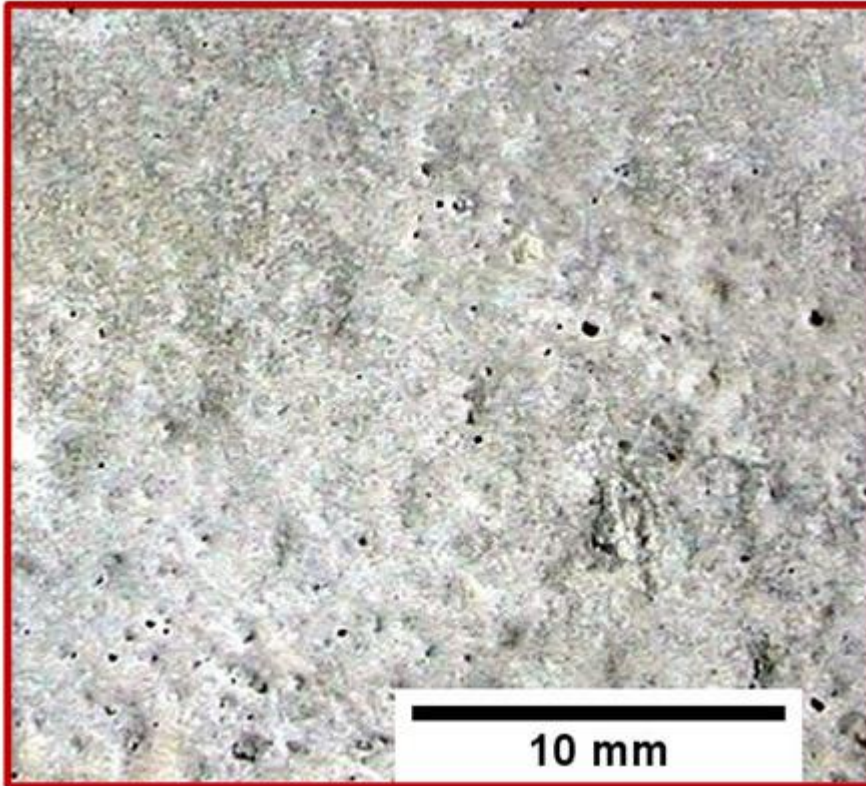

Typical optical views of the surfaces of the overlay

Introduction & background

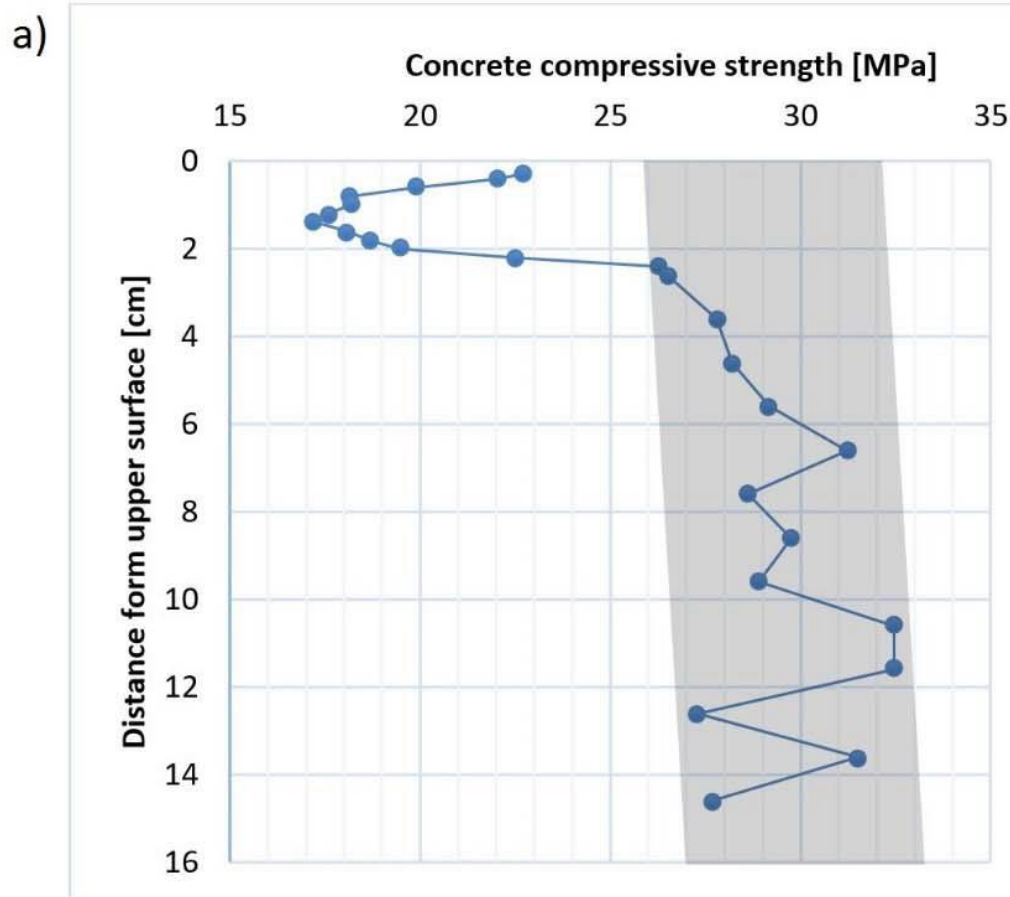

Example of: a) the distribution of concrete compressive strength versus the height of the floor, b) corresponding delamination

(Stawiski, B., & Radzik, Ł. (2017, October). Need to Identify Parameters of Concrete in the Weakest Zone of the Industrial Floor. In IOP Conference Series: Materials Science and Engineering (Vol. 245, No. 2, p. 022063). IOP Publishing)

The most important functional properties of the overlays are the:

- compressive strength,
- flexular strength,
- subsurface tensile strength
- abrasion resistance.

To ensure these parameters, the following applies:

- surface hardening,
- impregnation,
- reinforcement with dispersed reinforcement (fibers).

The latest attempts to modify the selected properties of cement mortars and concrete with the addition of nanoparticles

Investigated property	Type of the nanoparticle						
	SiO ₂	Al ₂ O ₃	CuO	TiO ₂	ZnO ₂	Fe ₂ O ₃	Cr ₂ O ₃
Porosity	+	+	+	+	+	-	+
Absorptivity	-	-	-	-	-	+	+
Watertightness	-	-	-	-	-	-	-
Compressive strength	+	+	+	+	-	+	+
Tensile strength	+	-	-	-	-	+	+
Flexular strength	+	+	-	-	+	+	+
Abrasion resistance	+	+	-	+	-	-	-
Subsurface tensile strength	-	-	-	-	-	-	-

+ investigated, - not investigated

The aim of the research was to determine the effect of modifying the cement mortar of the surface layer with selected nanoparticles on the following functional parameters:

- compressive strength,
- flexular strength,
- subsurface tensile strength
- abrasion resistance.

Compositions of mortars from which the overlay was made (calculated on 100g of sand)

Nr	Opis	Sand	Cement	Water	Plasticizer	Al ₂ O ₃	SiO ₂	TiO ₂
	[%]	[g]						
0	no additive (reference mortar)	100	73,3	22	0,37			
1	with SiO ₂ 0,5%	100	73,3	22	0,37		0,37	
2	with SiO ₂ 1,0%	100	73,3	22	0,37		0,73	
3	with SiO ₂ 1,5%	100	73,3	22	0,37		1,10	
4	with TiO ₂ 0,5%	100	73,3	22	0,37			0,37
5	with TiO ₂ 1,0%	100	73,3	22	0,37			0,73
6	with TiO ₂ 1,5 %	100	73,3	22	0,37			1,10
7	with Al ₂ O ₃ 0,5%	100	73,3	22	0,37	0,37		
8	with Al ₂ O ₃ 1,0%	100	73,3	22	0,37	0,73		
9	with Al ₂ O ₃ 1,5%	100	73,3	22	0,37	1,10		

Materials used:

- quartz dried sand with a maximum aggregate grain diameter of 2 mm,
- cement CEM-I 42.5R - cement plant Góraźdze,
- Superplastifier - SIKA Visco Crete 20-HE,
- ground for substrates - Weber Saint-Gobain Primo,
- SiO₂ with a particle size less than 20nm,
- TiO₂ with a particle size less than 25nm,
- Al₂O₃ with a particle size less than 50nm.

Selected properties of used nanoparticles (based on the manufacturer's data)

Type	Type of the property				
	Maximum particle size [nm]	Molecular mass[g/mol]	Surface area[m ² /g]	Density in 25°C [g/mL]	Bulk density [g/mL]
SiO₂	20	60,08	no data	from 2,2 to 2,6	0,011
TiO₂	25	79,87	from 45 to 55	3,9	od 0,04 do 0,06
Al₂O₃	50	101,96	more than 40	no data	no data

$$f_h = \frac{4 \cdot F_b}{\pi \cdot D_f^2}$$

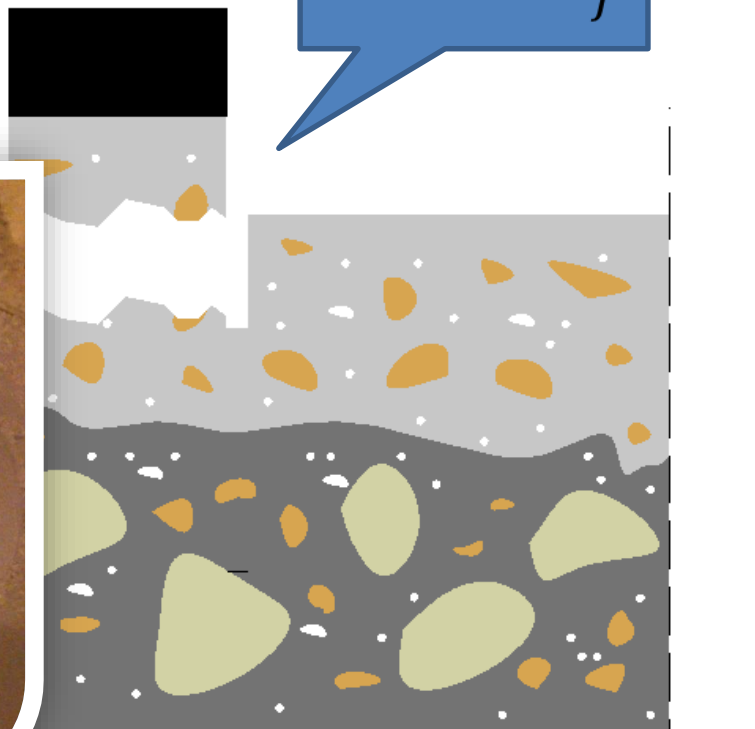

Fragment of the overlay after testing
its subsurface tensile strength

The test stand to measure the subsurface tensile strength of the overlay



View of the surface of the overlay after the pull-off tests

A measure of abrasiveness is the average volume loss ΔV of a cubic sample subjected to abrasion on a Boehme disc covered with an abrasive.



View of the test bench for testing abrasiveness on the Boehme disc



Widok próbek do badania ścieralności na tarczy Boehme'go

Test methodology

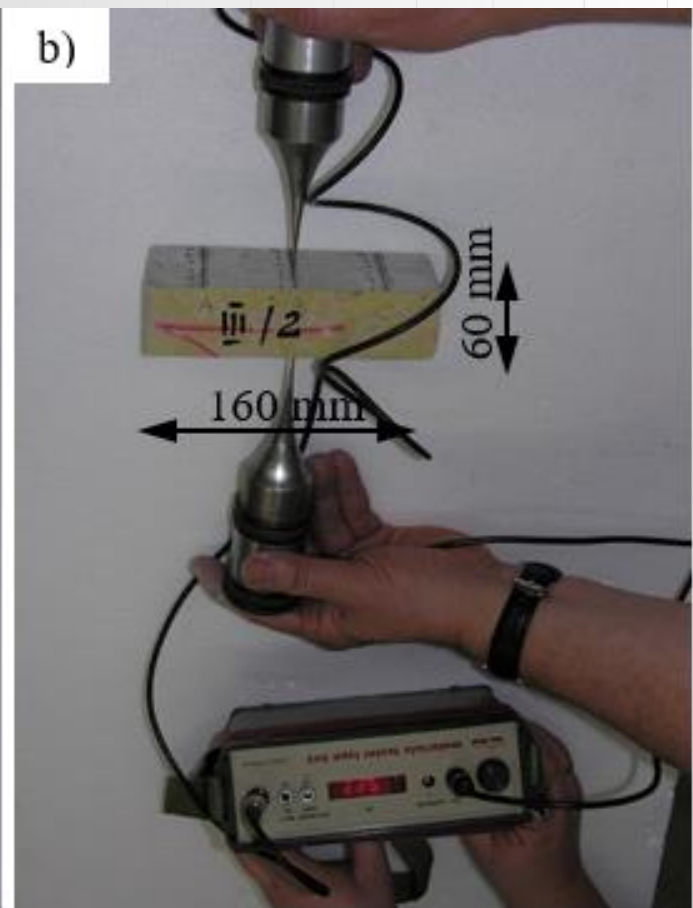
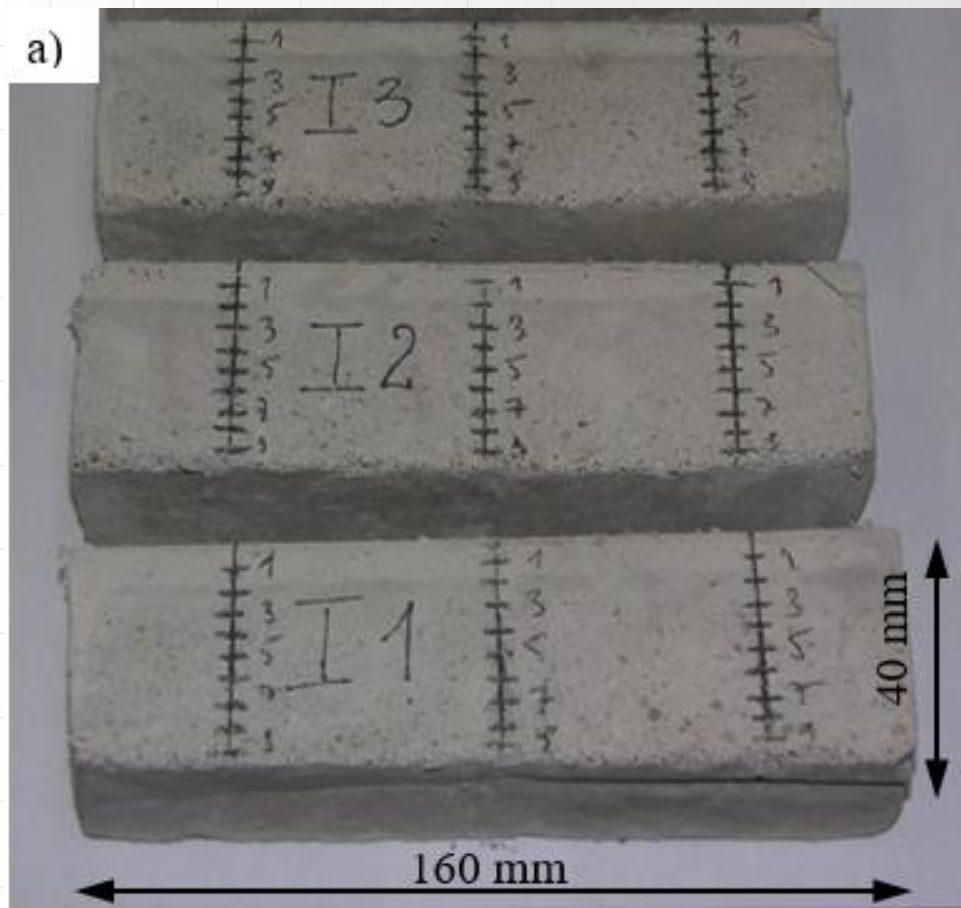

Exemplary view of: a) beam specimens prepared for ultrasonic tests, b) specimens tested along its thickness using the ultrasonic method

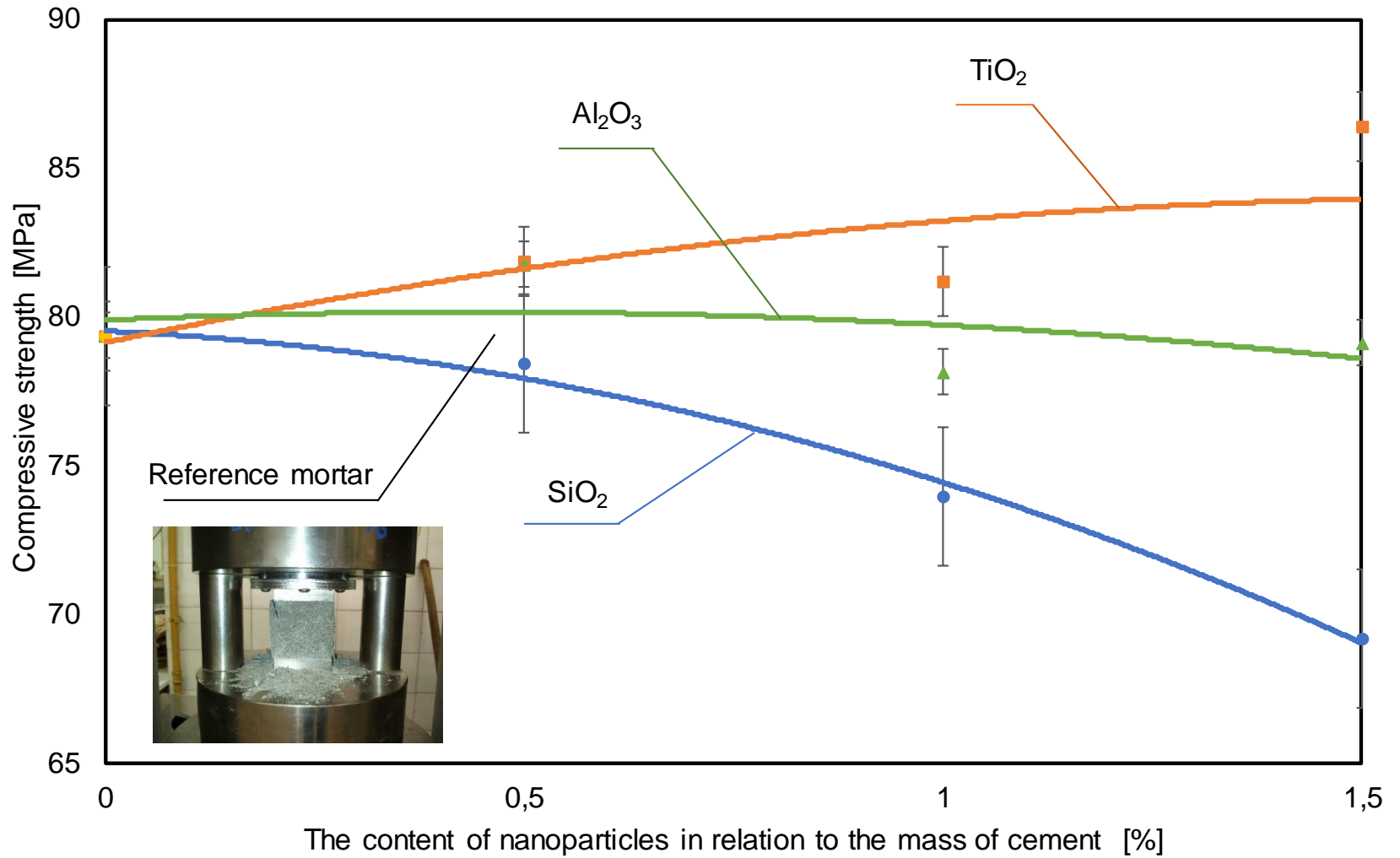

The effect of the nanoparticles on the compressive strength of the overlay

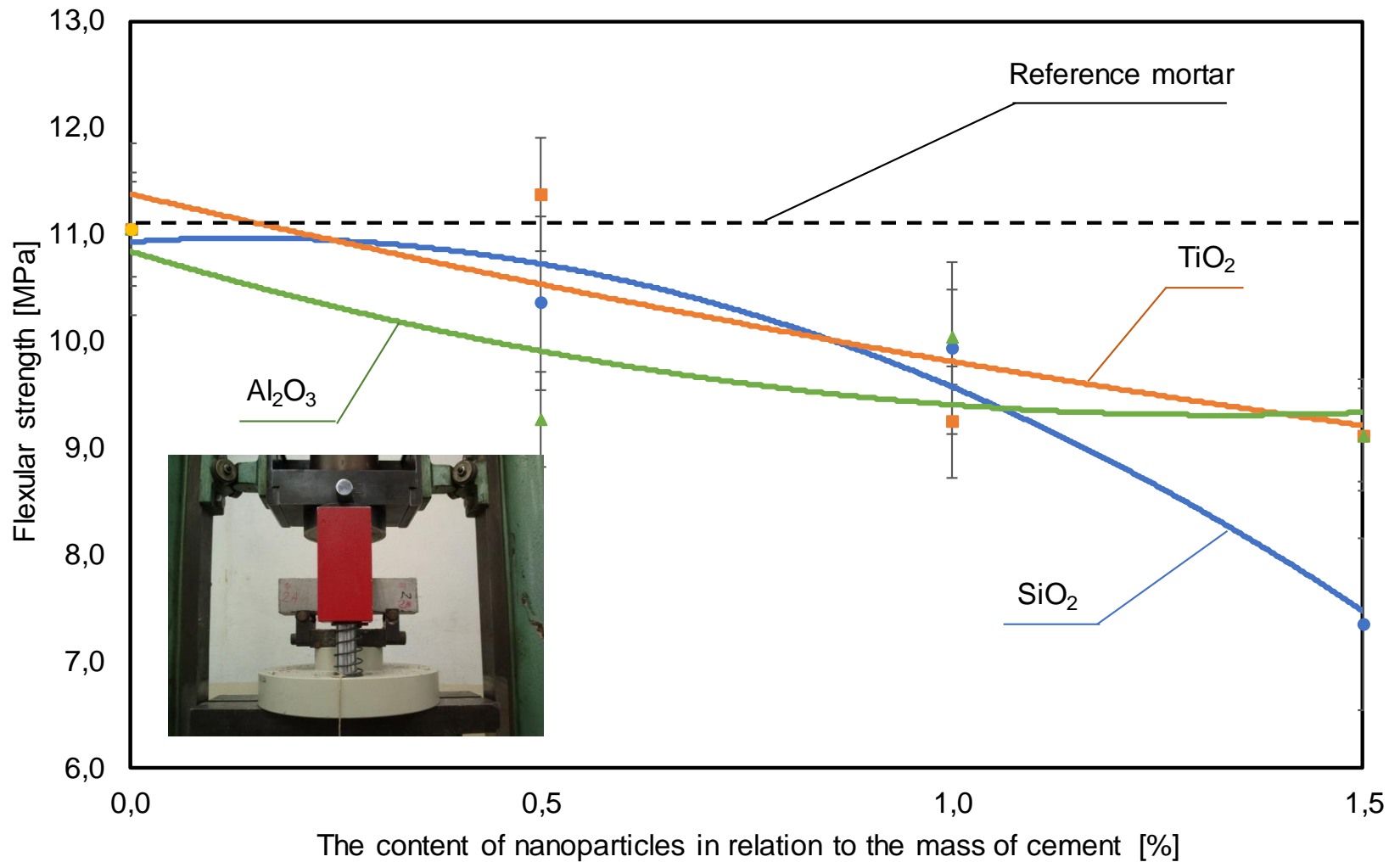

The effect of the nanoparticles on the flexural strenght of the overlay

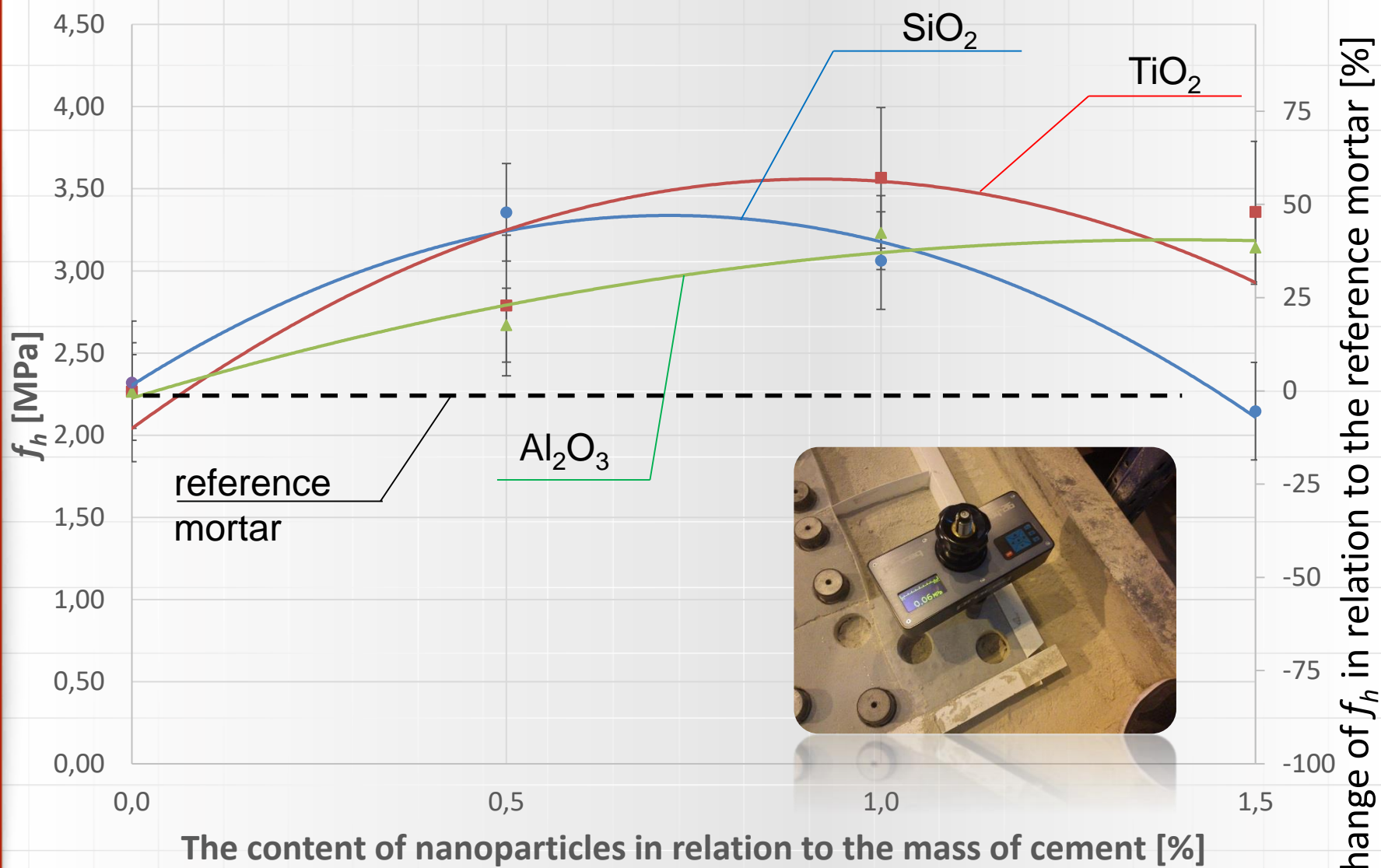

The effect of the nanoparticles on the subsurface tensile strength of the overlay

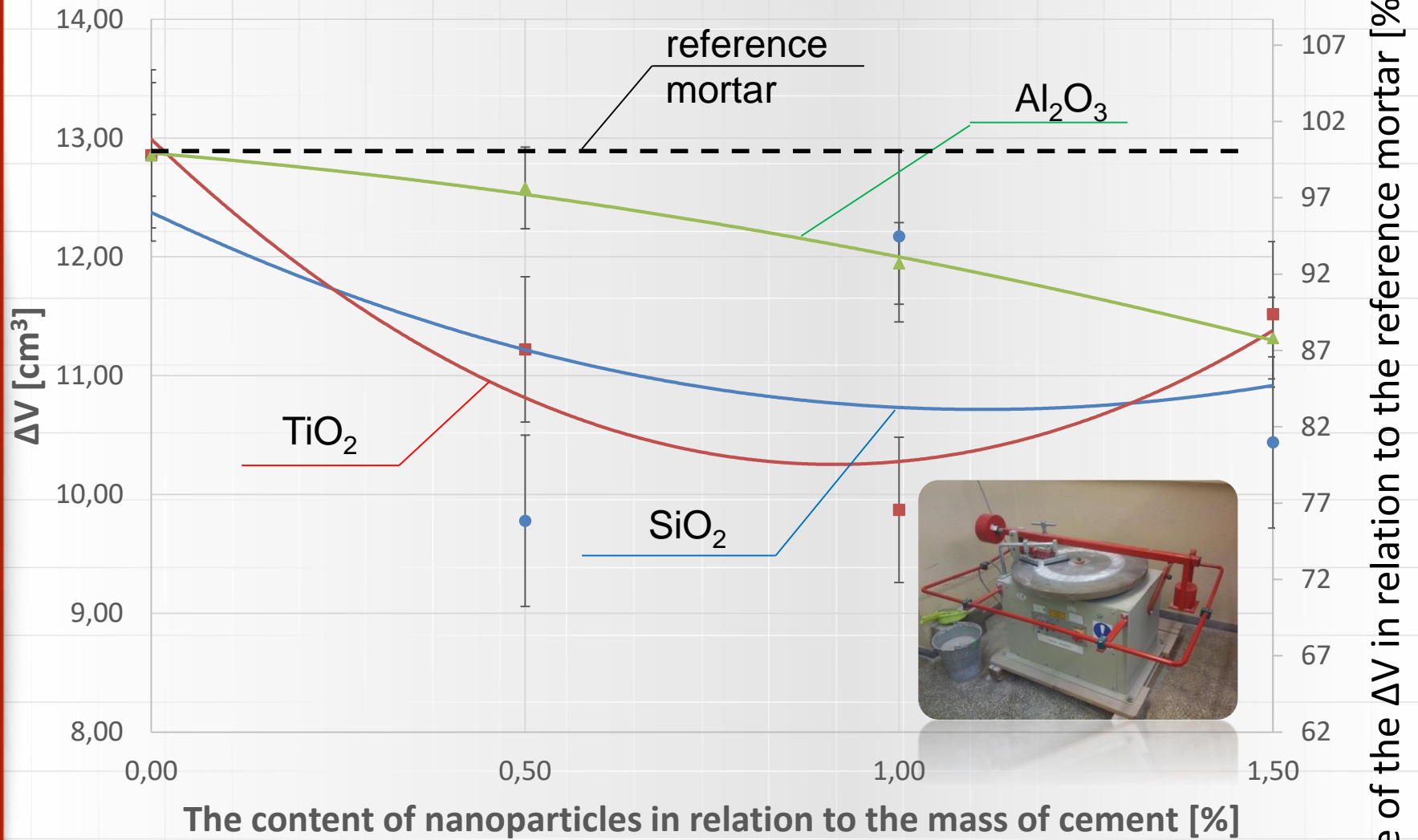

The effect of the nanoparticles on the abrasion resistance of the overlay

Change of the ΔV in relation to the reference mortar [%]

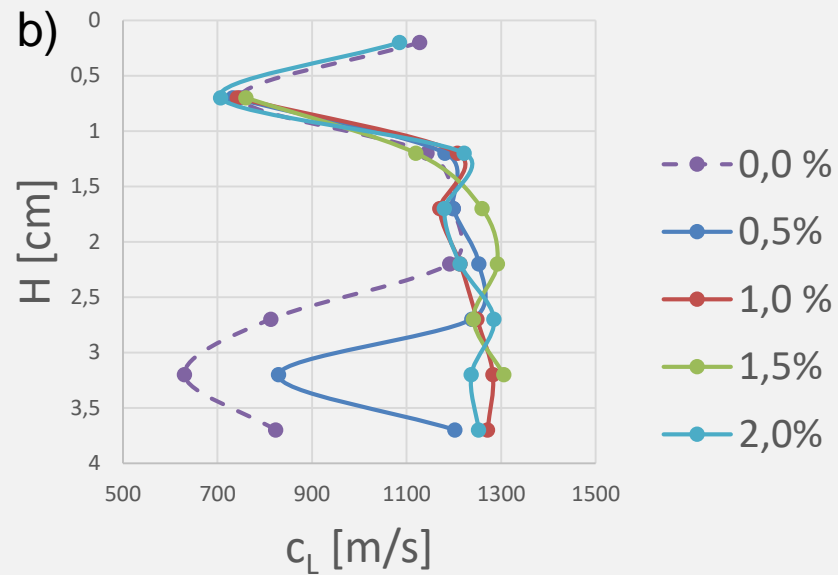
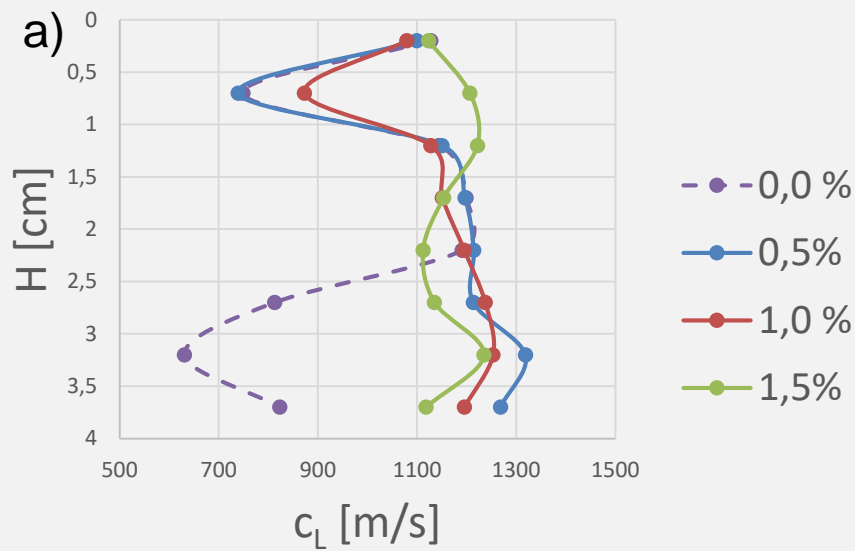

Rys. 8. The velocity of the ultrasonic wave as a function of the thickness of the sample for mortar modified by:

- a) SiO_2
- b) TiO_2
- c) Al_2O_3

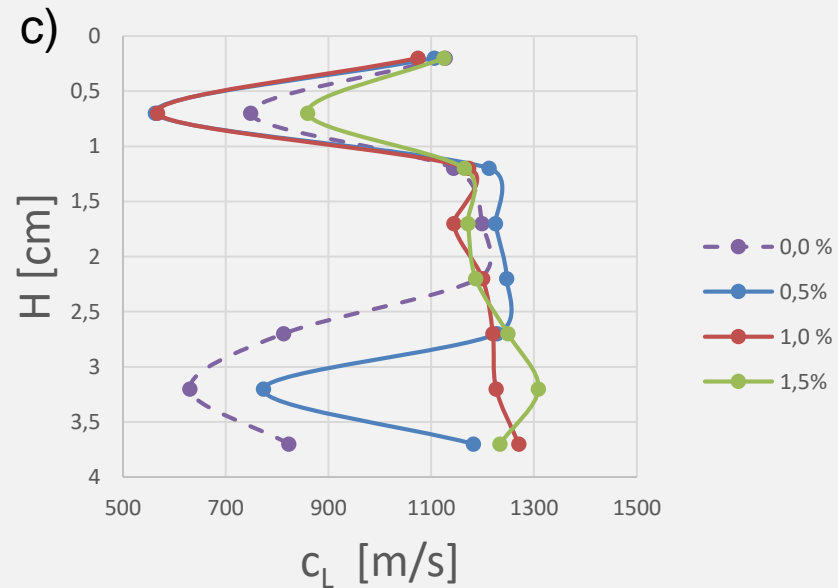

Tasks to be performed for the next class

1. Describe 3 main materials (or processes) used in your research using 3 keywords,
2. Search for scientific articles in Scopus using combination of selected 3 keywords,
3. Describe the content of 3 most cited articles based on your Scopus search.